

---

## Pch Load Switch IC with Current Sense and Voltage Sense

---

NO.EA-292-160122

### OUTLINE

The R5550K Series are CMOS-based load switch ICs. Pch Tr. is used to achieve low On resistance (TYP.180mΩ) and low supply current (TYP. 2.6μA at no-load operation). Internally, a single IC consists of a voltage reference unit, an error amplifier, resistors for setting output voltage and a current limit circuit. Output voltage is fixed inside the IC with high accuracy. The R5550K is suitable for monitoring abnormal current which may flow from lithium ion battery (one cell) to power lines connected to each load. If the abnormal current is detected, the switch turns off after a certain period of time (Dead-time).

If overcurrent is detected, switch turns off after dead-time of 10ms. If the output current exceeds the output current limit, the output current limit circuit immediately controls the output current after the short current response time of 4μs. Then, switch turns off after dead-time of 1.33ms.

The R5550K also includes a voltage sense pin which monitors abnormal voltage. If abnormal voltage is detected, switch turns off after dead-time of 10ms.

As protection circuits, the R5550K contains an output current limit circuit, a short-current protection circuit, and an undervoltage lockout (UVLO) circuit.

The R5550K is available in a DFN(PLP)1010-4F package which enables the high-density mounting.

### FEATURES

- A single built-in Pch MOSFET
- Input Voltage Range ..... 2.3V to 5.25V
- Supply Current ( $I_{OUT}=0mA$ ) ..... TYP. 2.6μA
- Switch On Resistance ..... TYP. 180mΩ ( $V_{IN}=3.3V$ )
- Output Current ..... MIN. 1000mA
- Package ..... DFN(PLP)1010-4F
- Current Limit Threshold ..... MIN. 300mA
- Output Current Limit ..... MIN. 1000mA
- Switching Operation (After turn-off) ..... Automatic Recovery Type

### APPLICATIONS

- Load Switch for portable communication equipments

# BLOCK DIAGRAMS

R5550K001A

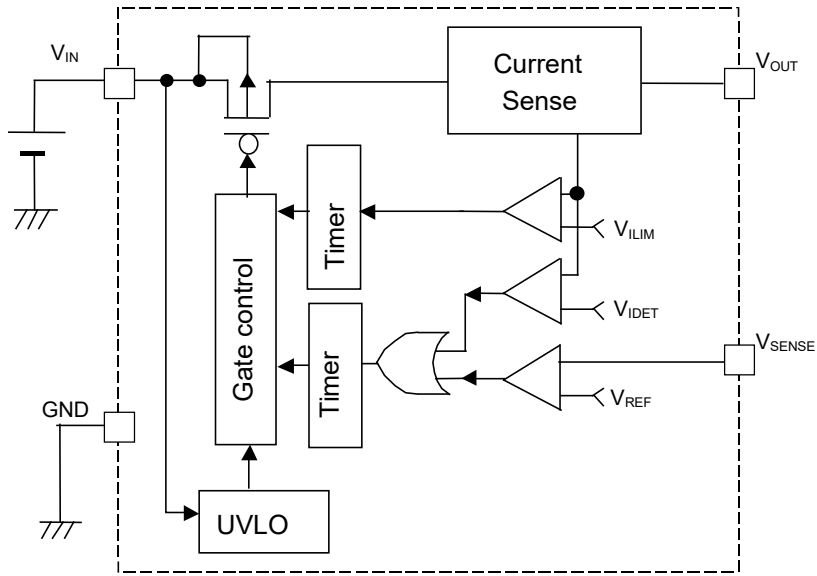

## SELECTION GUIDE

| Product Name  | Package         | Quantity per Reel | Pb Free | Halogen Free |
|---------------|-----------------|-------------------|---------|--------------|
| R5550K001A-TR | DFN(PLP)1010-4F | 10,000 pcs        | Yes     | Yes          |

001: Designation of current limit threshold, output current limit and protection delay time

Current Limit Threshold: 300mA

Output Current Limit: 1000mA

Protection Delay Time: Refer to Table 1 below.

**Table 1. Protection Delay Time**

| Setting No. | Delay Time                                    | Protection Delay Time |               |              |
|-------------|---|-----------------------|---------------|--------------|
|             |   | Dead-time [ms]        | Off-time [ms] | On-time [ms] |
| 001         | Current Limit Threshold/<br>SENSE Pin Voltage | 10                    | 80            | 2.5          |
|             | Output Current Limit                          | 1.33                  | 80            | 1.33         |

As for Dead-time, OFF-time and ON-time, refer to *Theory of Operation*.

A : Designation of version

Automatic recovery type protection, Voltage SENSE pin

## PIN DESCRIPTION

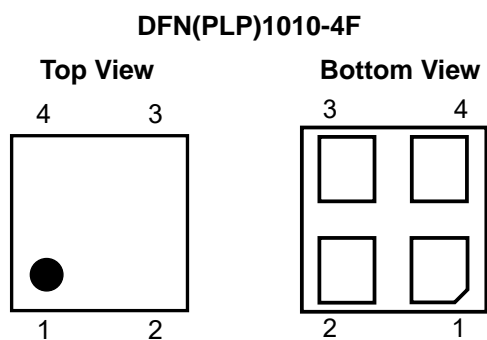

## R5550K001A

| Pin No. | Symbol      | Description       |
|---------|-------------|-------------------|
| 1       | GND         | Ground Pin        |
| 2       | $V_{SENSE}$ | Voltage SENSE Pin |
| 3       | $V_{IN}$    | Input Pin         |
| 4       | $V_{OUT}$   | Output Pin        |

## ABSOLUTE MAXIMUM RATINGS

| Symbol      | Item  | Rating                 | Unit |
|-------------|---|------------------------|------|
| $V_{IN}$    | Input Voltage                               | -0.3 to 6.0            | V    |
| $V_{SENSE}$ | SENSE Pin Voltage                           | -0.3 to 6.0            | V    |
| $V_{OUT}$   | Output Voltage                              | -0.3 to $V_{IN} + 0.3$ | V    |
| $I_{OUT}$   | Output Current                              | 1000                   | mA   |
| $P_D$       | Power Dissipation (Standard Land Pattern)*1 | 300                    | mW   |
| $T_a$       | Operating Temperature Range                 | -40 to +85             | °C   |
| $T_{stg}$   | Storage Temperature Range                   | -55 to +125            | °C   |

\*1 For more information about Power Dissipation and Standard Land Pattern, please refer to *POWER DISSIPATION*.

### ABSOLUTE MAXIMUM RATINGS

Electronic and mechanical stress momentarily exceeded absolute maximum ratings may cause the permanent damages and may degrade the lifetime and safety for both device and system using the device in the field. The functional operation at or over these absolute maximum ratings is not assured.

### RECOMMENDED OPERATING CONDITIONS (ELECTRICAL CHARACTERISTICS)

All of electronic equipment should be designed that the mounted semiconductor devices operate within the recommended operating conditions. The semiconductor devices cannot operate normally over the recommended operating conditions, even if when they are used over such conditions by momentary electronic noise or surge. And the semiconductor devices may receive serious damage when they continue to operate over the recommended operating conditions.

## ELECTRICAL CHARACTERISTICS

$V_{IN}=3.7V$ ,  $I_{OUT}=1mA$ ,  $C_{IN}=0.1\mu F$ ,  $C_{OUT}=none$ , unless otherwise noted.

The specifications surrounded by   are guaranteed by Design Engineering at  $-40^{\circ}C \leq T_a \leq 85^{\circ}C$ .

## R5550K001A

(Ta=25°C)

| Symbol       | Item                                      | Conditions   | Min.   | Typ. | Max.   | Unit |
|--------------|---|--|--|------|--|------|
| $V_{IN}$     | Input Voltage                             |  | <span style="border: 1px solid black; padding: 0 2px;">2.3</span>    |      | <span style="border: 1px solid black; padding: 0 2px;">5.25</span>   | V    |
| $R_{ON}$     | Switch On Resistance                      | $I_{OUT}=100mA^{*1}$ , $V_{IN}=3.3V$                         |  | 180  |  | mΩ   |
| $I_{OUT}$    | Output Current                            |  | <span style="border: 1px solid black; padding: 0 2px;">1000</span>   |      |  | mA   |
| $I_{SS}$     | Supply Current                            | $I_{OUT}=0mA$ , $V_{SENSE}=2.0V$                             |  | 2.6  | 15   | μA   |
| $I_{DET}$    | Current Limit Threshold <sup>*3</sup>     |  | <span style="border: 1px solid black; padding: 0 2px;">300</span>    | 460  | <span style="border: 1px solid black; padding: 0 2px;">624</span>    | mA   |
| $I_{LIM}$    | Output Current Limit <sup>*3</sup>        | Initial Saturation Region <sup>*4</sup>                      | <span style="border: 1px solid black; padding: 0 2px;">1130</span>   | 1470 | <span style="border: 1px solid black; padding: 0 2px;">1790</span>   | mA   |
| $I_{SC}$     | Short Current Limit                       | $V_{OUT}=0V$   |  | 300  |  | mA   |
| $V_{DET}$    | SENSE Pin Detector Threshold              | $V_{SENSE}$ falling  | x 0.97   | 0.5  | x 1.03   | V    |
| $V_{HYS}$    | SENSE Pin Hysteresis                      | $V_{SENSE}$ rising   | 0.63   | 0.9  | 1.2  | V    |
| $T_{DET1}$   | Dead-time 1                               | $V_{SENSE} \leq V_{DET}$ or $I_{DET} \leq I_{OUT} < I_{LIM}$ | <span style="border: 1px solid black; padding: 0 2px;">x 0.72</span> | 10   | <span style="border: 1px solid black; padding: 0 2px;">x 1.32</span> | ms   |
| $T_{OFF1}$   | OFF-time 1                                |  | <span style="border: 1px solid black; padding: 0 2px;">x 0.71</span> | 80   | <span style="border: 1px solid black; padding: 0 2px;">x 1.34</span> | ms   |
| $T_{ON1}$    | ON-time 1                                 |  | <span style="border: 1px solid black; padding: 0 2px;">x 0.72</span> | 2.5  | <span style="border: 1px solid black; padding: 0 2px;">x 1.35</span> | ms   |
| $T_{DET2}$   | Dead-time 2                               | $V_{OUT}=0V$ or $I_{OUT} > I_{LIM}$                          | <span style="border: 1px solid black; padding: 0 2px;">x 0.65</span> | 1.33 | <span style="border: 1px solid black; padding: 0 2px;">x 1.35</span> | ms   |
| $T_{OFF2}$   | OFF-time 2                                |  | <span style="border: 1px solid black; padding: 0 2px;">x 0.65</span> | 80   | <span style="border: 1px solid black; padding: 0 2px;">x 1.35</span> | ms   |
| $T_{ON2}$    | ON-time 2                                 |  | <span style="border: 1px solid black; padding: 0 2px;">x 0.65</span> | 1.33 | <span style="border: 1px solid black; padding: 0 2px;">x 1.35</span> | ms   |
| $T_r$        | Start-up Time                             | $V_{OUT}=10\%$ to $90\%$ , $C_{OUT}=0.1\mu F$                |  | 12   |  | μs   |
| $T_{rdelay}$ | Start-up Delay Time                       | " $V_{IN}=V_{UVLO}$ " to " $V_{OUT}=10\%$ "                  |  | 60   |  | μs   |
| $T_{SC}$     | Short Current Response Time <sup>*2</sup> | $V_{OUT}=0V$   |  | 4    |  | μs   |
| $V_{UVLO}$   | UVLO Release Voltage                      | $V_{IN}$ rising  | <span style="border: 1px solid black; padding: 0 2px;">2.0</span>    | 2.1  | <span style="border: 1px solid black; padding: 0 2px;">2.2</span>    | V    |
| $V_{HYSUV}$  | UVLO Hysteresis                           | $V_{IN}$ falling   |  | 0.2  |  | V    |

All test items listed under *ELECTRICAL CHARACTERISTICS* are done under the pulse load condition ( $T_j \approx T_a = 25^{\circ}C$ ) except Start-up Time, Start-up Delay Time, Short Current Response Time, Dead-time 2, OFF-time 2 and ON-time 2.

<sup>\*1</sup> As for  $R_{ON}$  when  $I_{OUT} > 100mA$ , refer to 12) *Switch ON Resistance vs. Output Current* of *TYPICAL CHARACTERISTICS*.

<sup>\*2</sup> Refer to 36) *Short-Protection-Circuit Transient Response* of *TYPICAL CHARACTERISTICS*.

<sup>\*3</sup> Each set value should be "Max.  $I_{DET} < Min. I_{LIM}$ ". Note: Do not use with  $I_{DET}=400mA$  and  $I_{LIM}=500mA$ .

<sup>\*4</sup>  $I_{LIM}$  could be influenced by the measurement time. All products were tested within the initial saturation region as shown in the following page.

**R5550KxxxA**

$I_{LIM\_SET} = 1000\text{mA}$   
 $T_a = 25^\circ\text{C}$

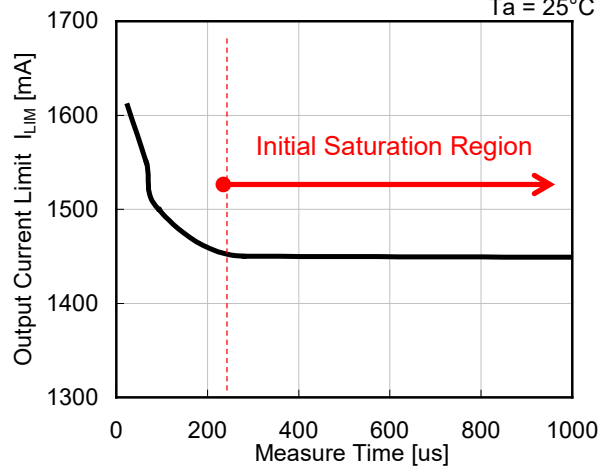
**Measurement Board Information**

- Board Size: 27.5mm x 40.0mm
- IC Mounting Position: Center of the board
- Board Material: Glass Cloth Epoxy Plastic (Single layer)
- Board Thickness: 1.6mm
- Diameter of Through-hole: 1.0mm
- Number of Through-holes: 12

## THEORY OF OPERATION

### Operation Example: R5550K001A with Automatic Recovery Protection and Voltage SENSE Pin

#### [1] Operation of Current Limit Detector Threshold ( $I_{DET}$ )

If  $I_{OUT}$  exceeds  $I_{DET}$ , Timer 1 starts to operate and the switch turns off after Dead-time 1. After OFF-time 1, the switch automatically turns on. If  $I_{OUT} \geq I_{DET}$  continues, the switch turns off again after ON-time 1. Afterwards, the switch repeats intermittent operation. If  $I_{OUT} < I_{DET}$ , the IC recognizes it as back in normal operation and start to output as usual.

Even if  $I_{OUT} < I_{DET}$  during OFF-time1, the switch automatically turns on after OFF-time 1.

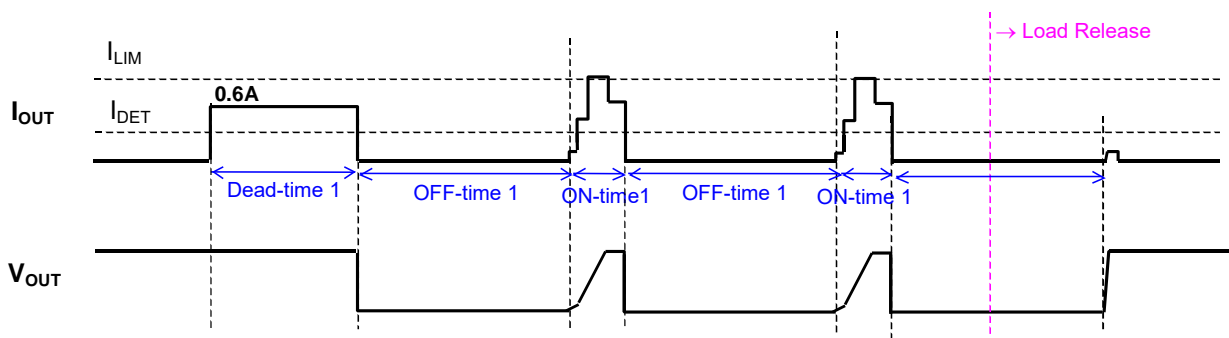

#### [2] Operation of Output Current Limit ( $I_{LIM}$ )

If  $I_{OUT}$  exceeds  $I_{LIM}$  (including output short-circuit),  $I_{OUT}$  becomes limited by  $I_{LIM}$  or  $I_{sc}$ . So, Timer 2 starts to operate and the switch turns off after Dead-time 2.

After OFF-time 2, the switch automatically turns on. If  $I_{OUT} \geq I_{LIM}$  or short current condition continues, the switch turns off again after ON-time 2. Afterwards,  $I_{OUT}$  the switch repeats intermittent operation. If  $I_{OUT} < I_{LIM}$ , the IC recognizes it as back in normal operation and start to output as usual.

Even if  $I_{OUT} < I_{LIM}$  during OFF-time2, the switch automatically turns on after OFF-time 2.

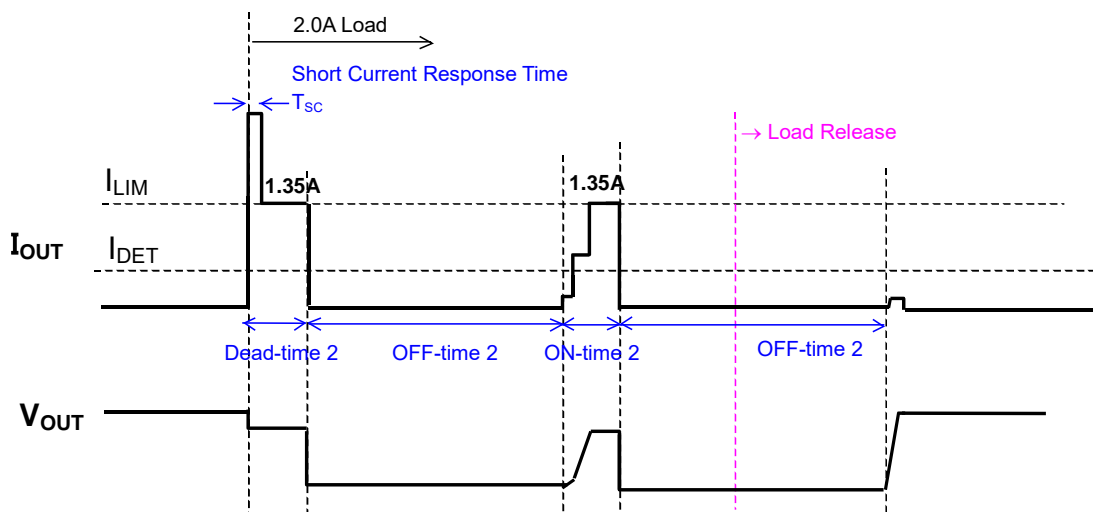



### [3] Operation of SENSE Pin Voltage ( $V_{SENSE}$ )

If  $V_{SENSE}$  falls below  $V_{DET}$ , Timer 1 starts to operate and the switch turns off after Dead-time 1. After OFF-time 1, the switch automatically turns on. If  $V_{SENSE} \leq V_{DET}$  continues, the switch turns off again after ON-time 1. Afterwards,  $I_{OUT}$  repeats intermittent operation.

If  $V_{SENSE} > (V_{DET} + V_{HYS})$ , when the switch is automatically turning on after OFF-time 1, the IC recognizes it as back in normal operation and start to output as usual.

Even if  $V_{SENSE} > (V_{DET} + V_{HYS})$  during OFF-time 1, the switch automatically turns on after OFF-time 1.

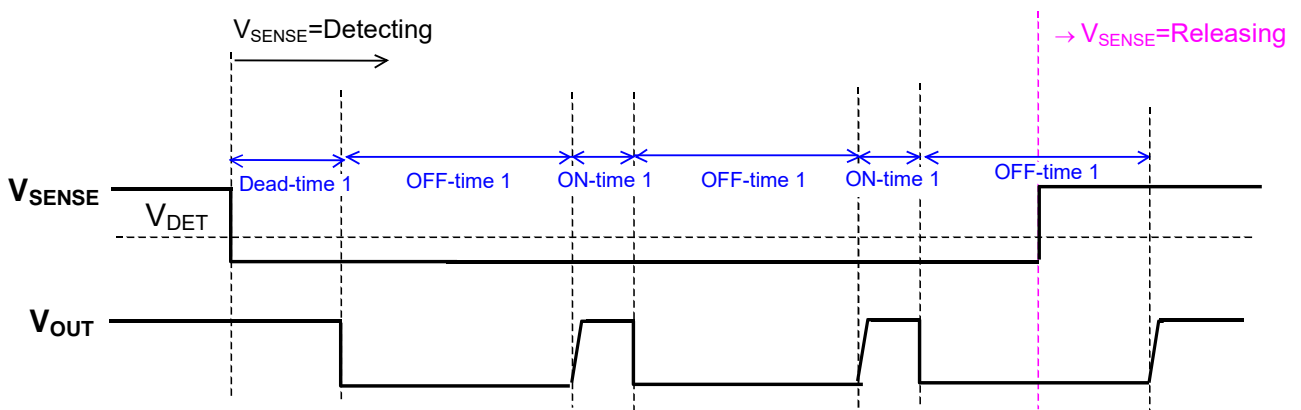

## TYPICAL APPLICATIONS AND TECHNICAL NOTES

### Typical Application

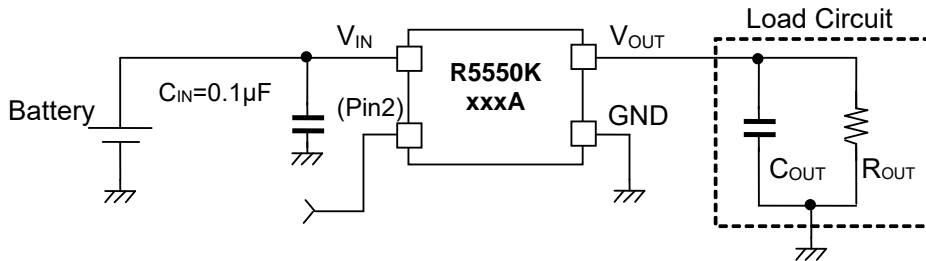

### Technical Notes

The R5550K does not require any bypass capacitor between  $V_{IN}$  and GND. However, it is recommended that a  $0.1\mu F$  or more capacitor be connected between  $V_{IN}$  and GND. Especially, if there's any possibility of generating spike noise due to the parasitic element (inductance) of  $V_{IN}$ , connect a proper size capacitor between  $V_{IN}$  and GND.

## POWER DISSIPATION (DFN(PLP)1010-4F )

Power Dissipation ( $P_D$ ) depends on conditions of mounting on board. This specification is based on the measurement conditions below.

### Measurement Conditions

|                  | Standard Land Pattern                       |
|------------------|---|
| Environment      | Mounting on Board (Wind Velocity=0m/s)      |
| Board Material   | Glass Cloth Epoxy Plastic (Double-sided)    |
| Board Dimensions | 40mm x 40mm x 1.6mm                         |
| Copper Ratio     | Topside: Approx. 50%, Backside: Approx. 50% |
| Through-holes    | $\phi$ 0.54mm x 24pcs                       |

### Measurement Result:

( $T_a=25^\circ\text{C}$ ,  $T_{j\text{max}}=125^\circ\text{C}$ )

|                    | Standard Land Pattern  |
|--------------------|--|
| Power Dissipation  | 300mW  |
| Thermal Resistance | $\theta_{ja} = (125-25^\circ\text{C})/0.3\text{W} = 330^\circ\text{C/W}$ |
|                    | $\theta_{jc} = 48^\circ\text{C/W}$                                       |

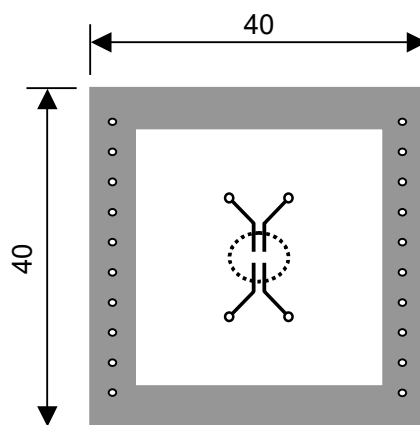
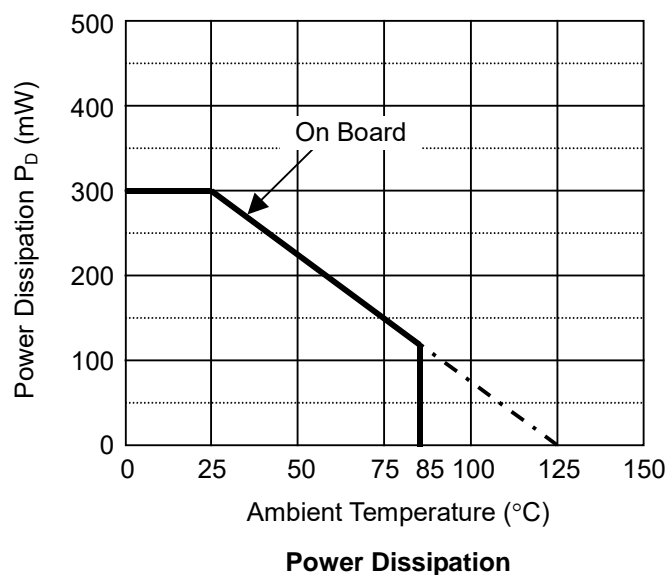

**Measurement Board Pattern**

 IC Mount Area (Unit : mm)

**TYPICAL CHARACTERISTICS**

1) Output Voltage vs. Output Current

**R5550K001A**

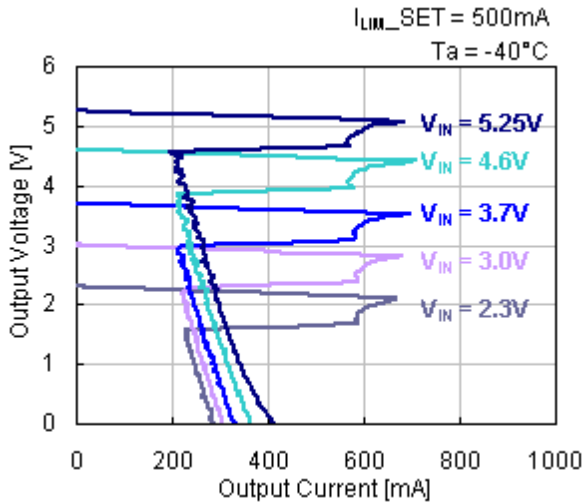

**R5550K001A**

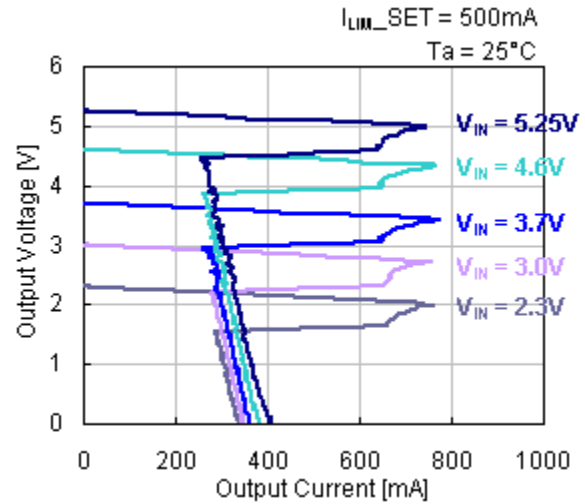

**R5550K001A**

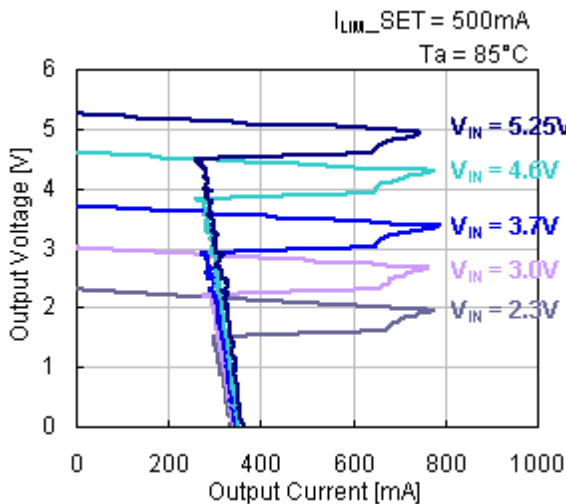

**R5550K001A**

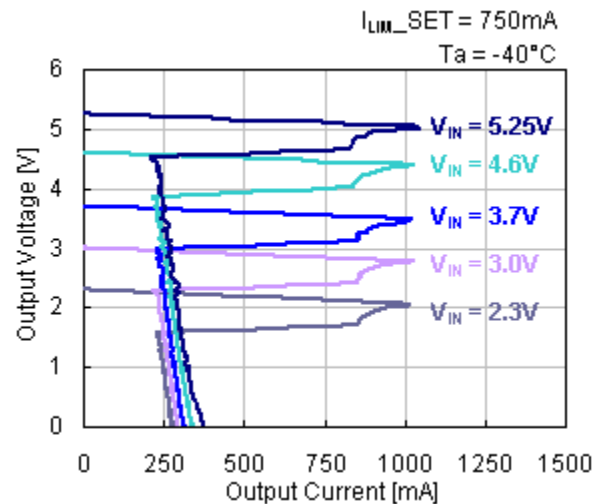

**R5550K001A**

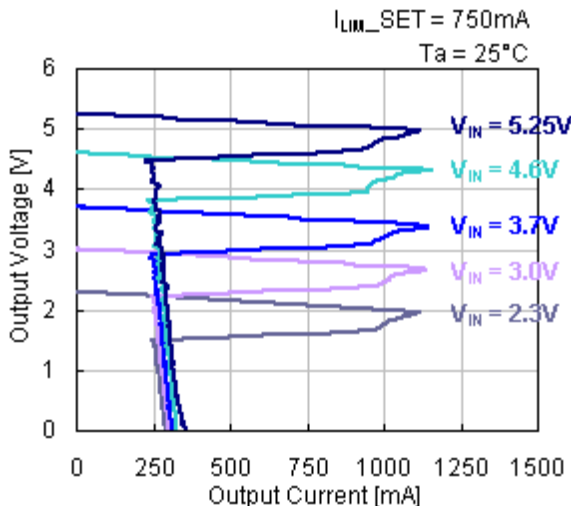

**R5550K001A**

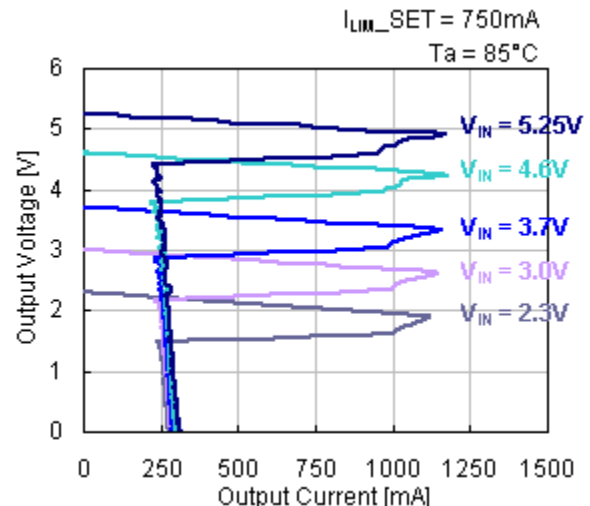

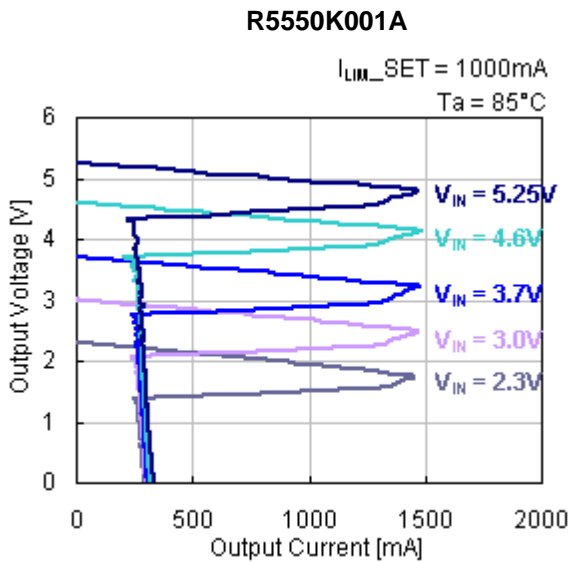
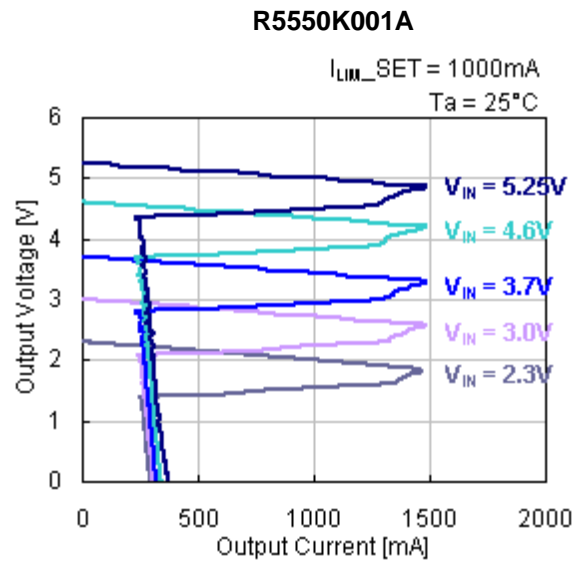
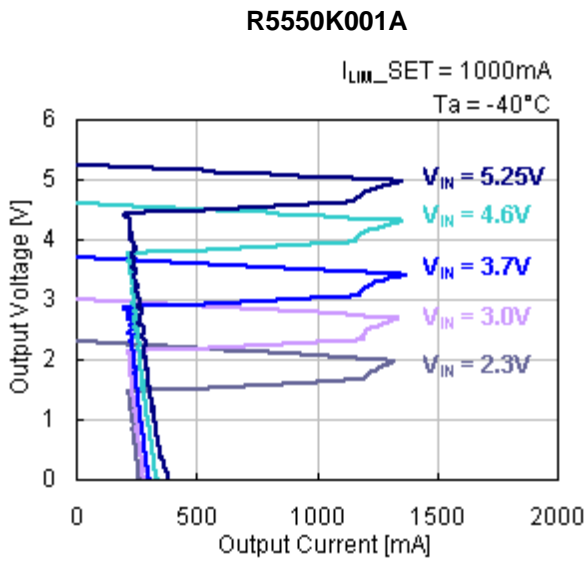

2) Current Limit vs. Temperature

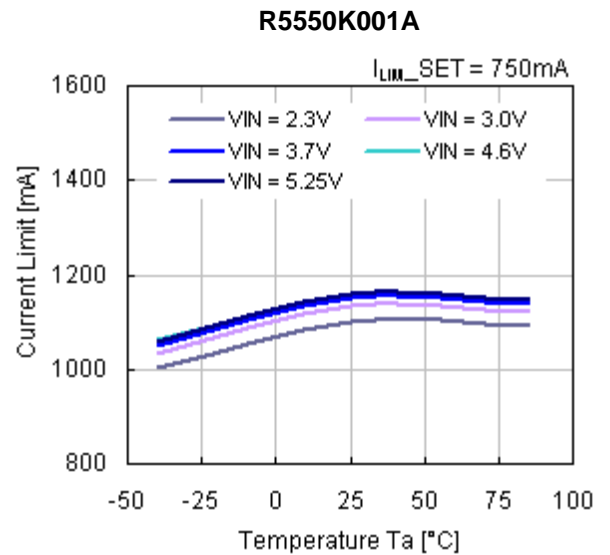
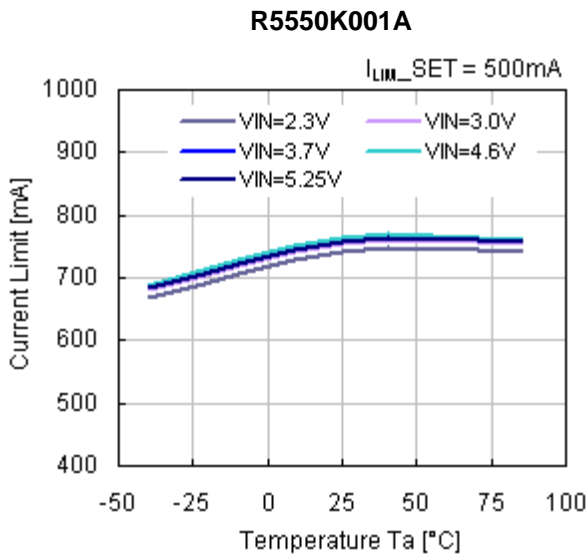

R5550K001A

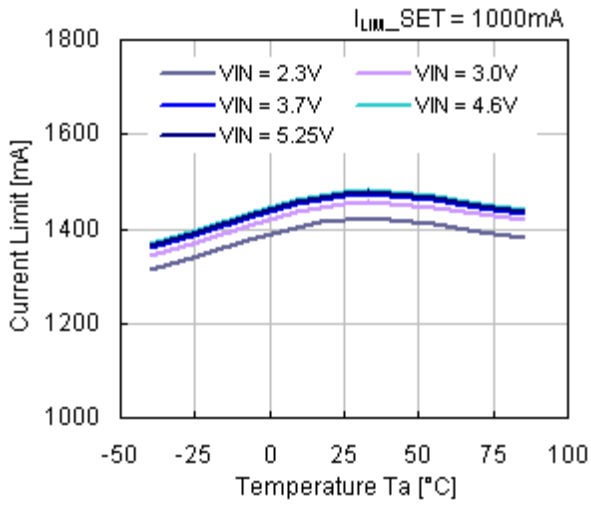

3) Current Limit vs. Input Voltage

R5550K001A

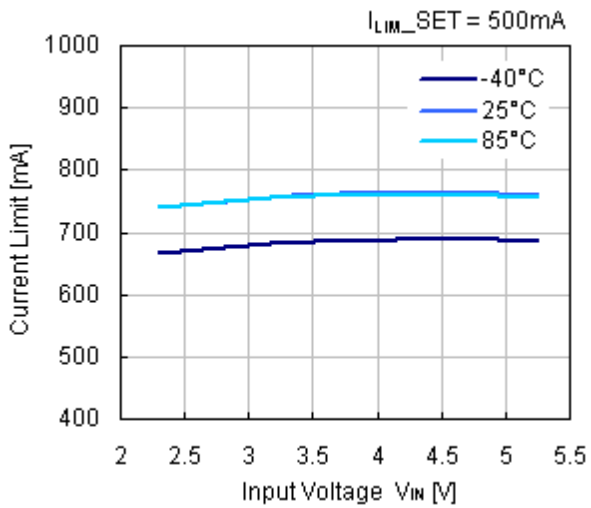

R5550K001A

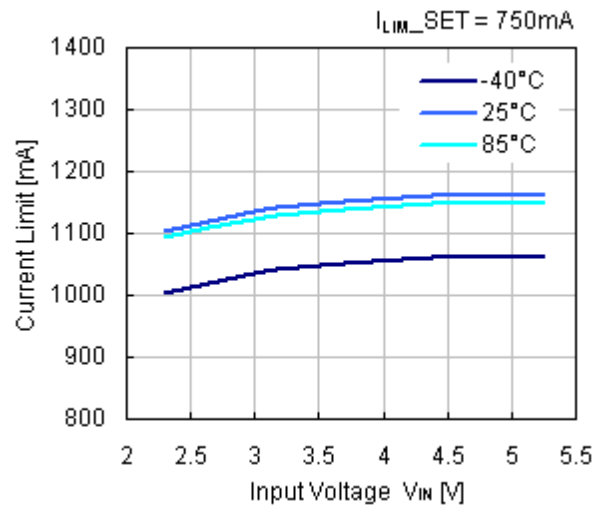

R5550K001A

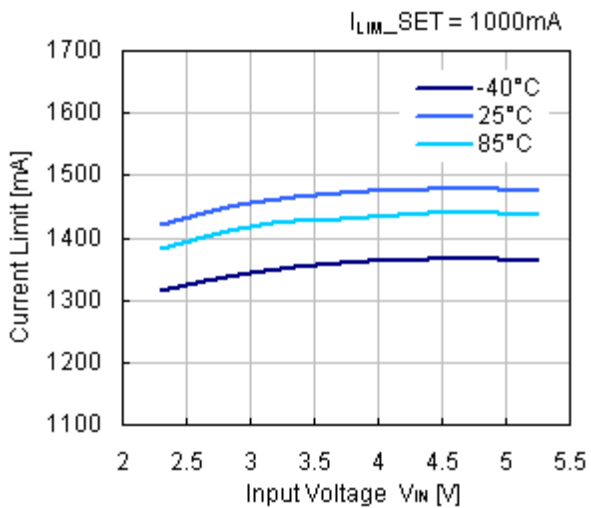

4) Output Current Detector Threshold vs. Temperature

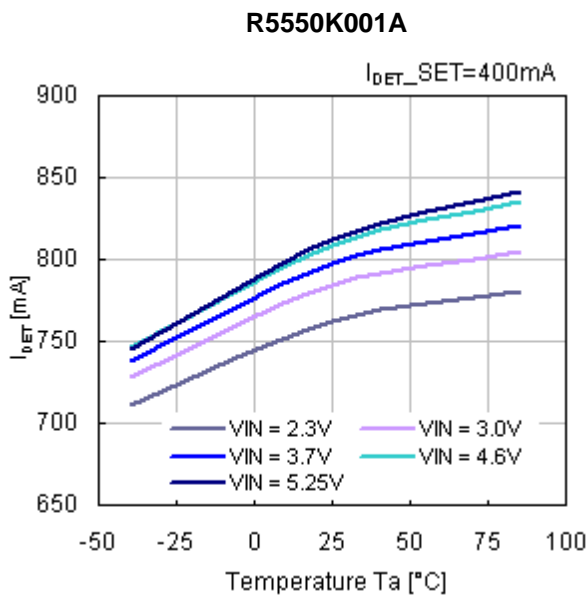
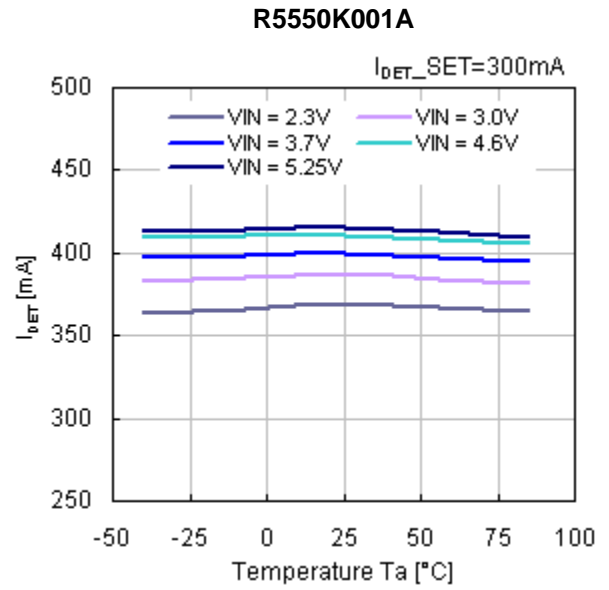
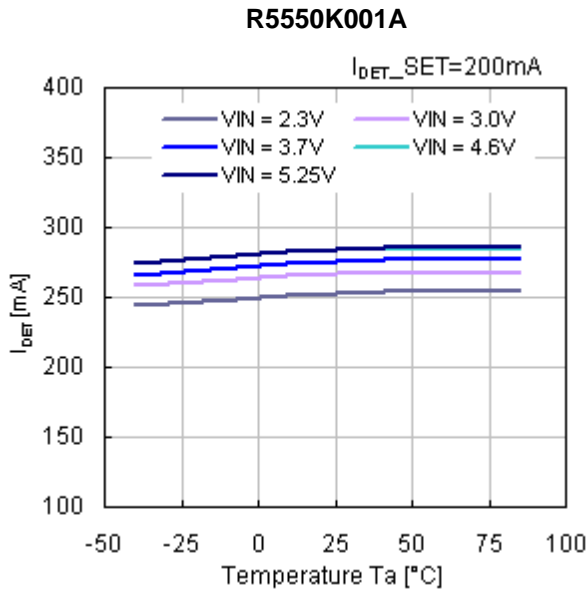

5) Output Current Detector Threshold vs. Input Voltage

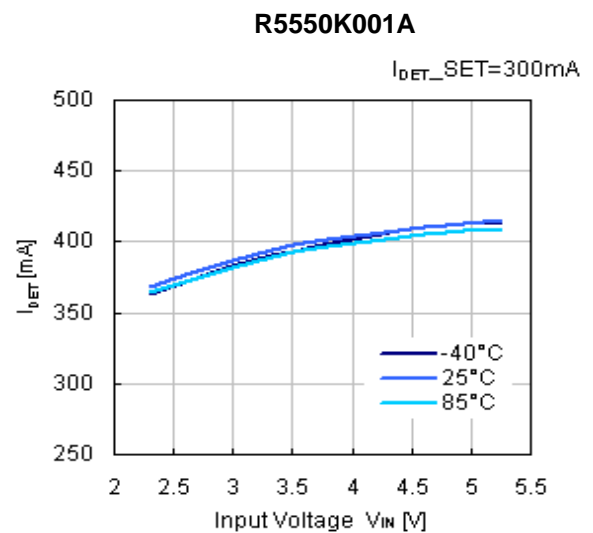
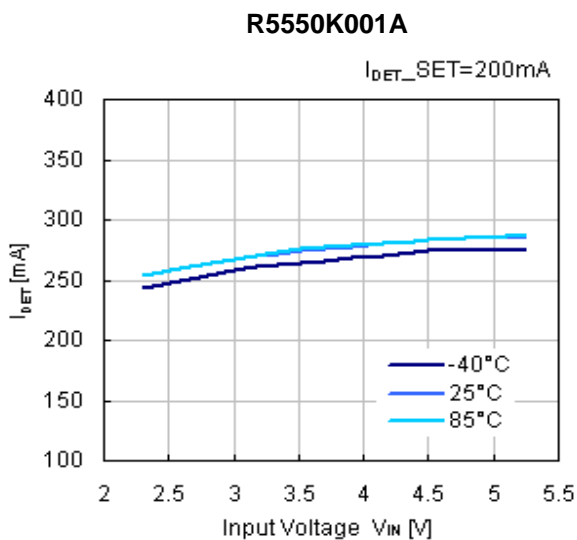

R5550K001A

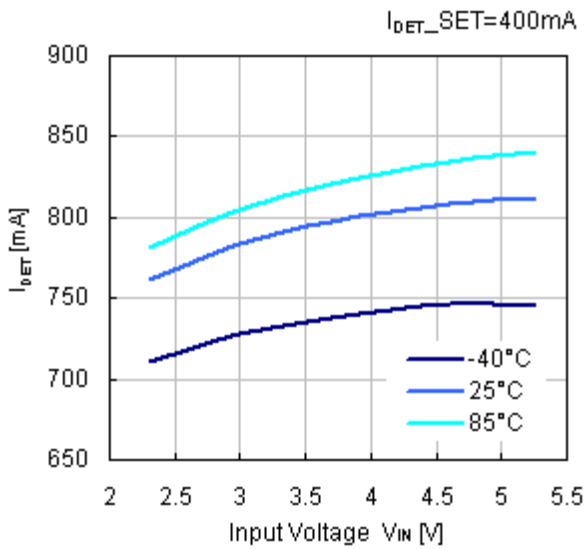

6) Short Current Limit vs. Temperature

R5550K001A

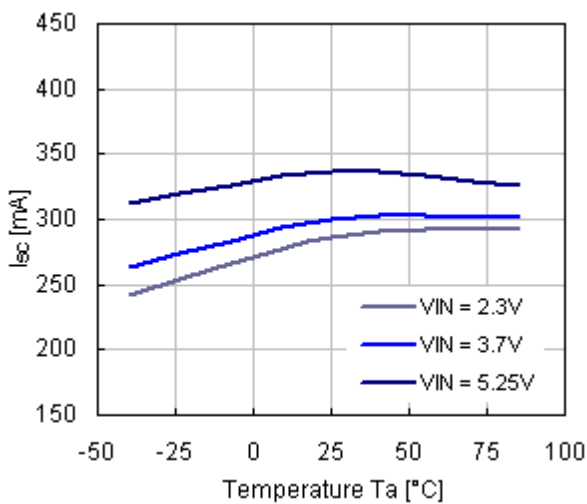

7) Short Current Limit vs. Input Voltage

R5550K001A

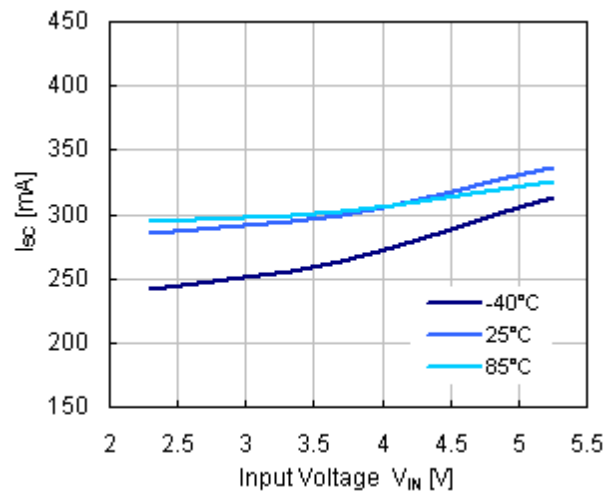

8) Supply Current Limit vs. Input Voltage

R5550K001A

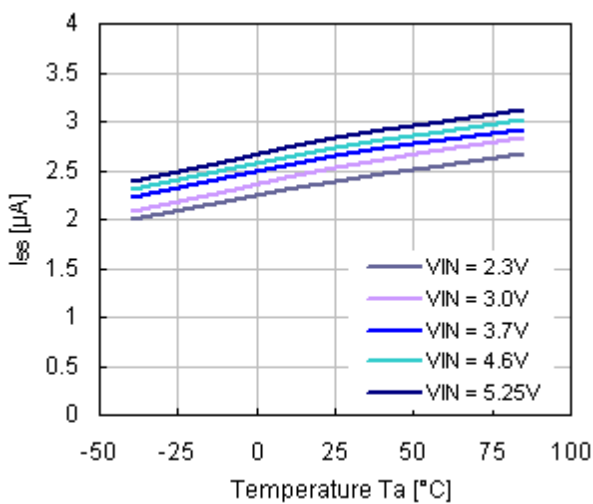

9) Supply Current vs. Input Voltage

R5550K001A

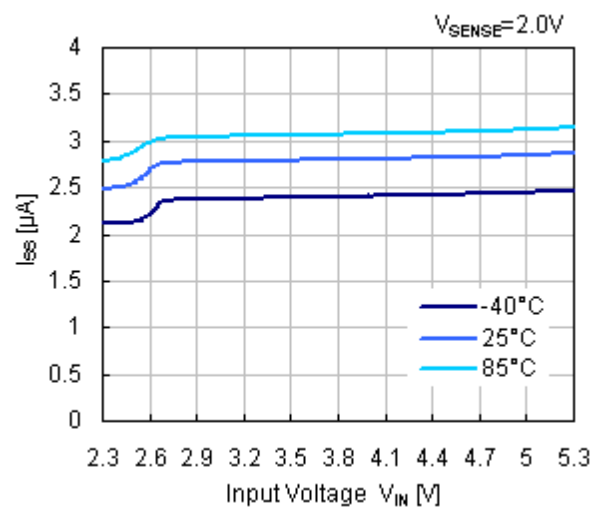



10) Switch ON Resistance vs. Temperature

R5550K001A

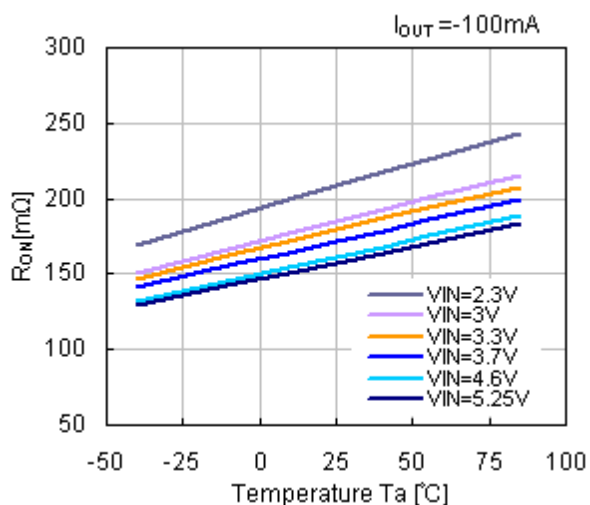

11) Switch ON Resistance vs. Input Voltage

R5550K001A

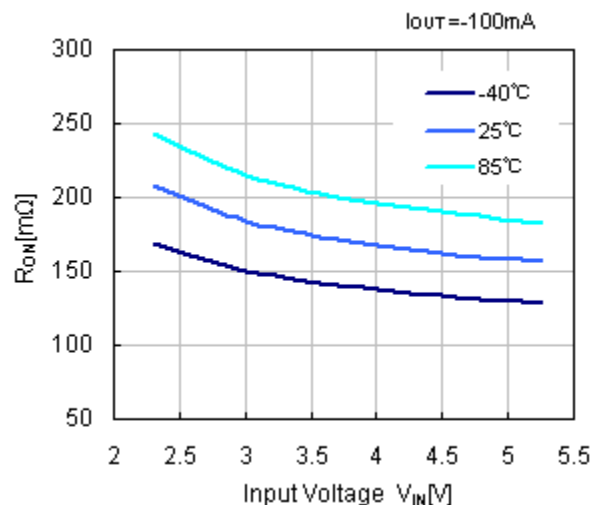

12) Switch ON Resistance vs. Output Current

R5550K001A

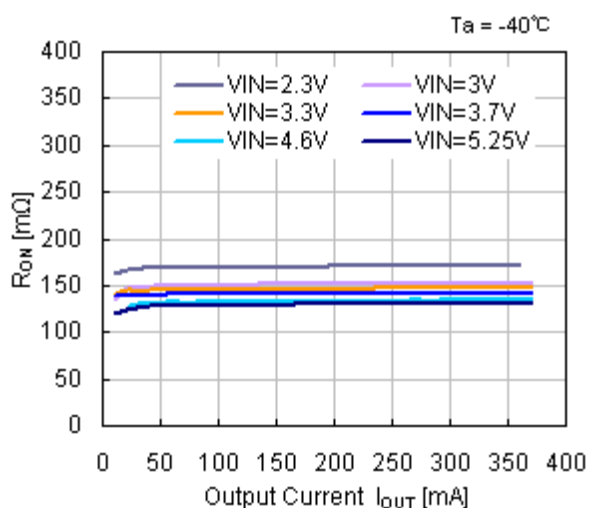

R5550K001A

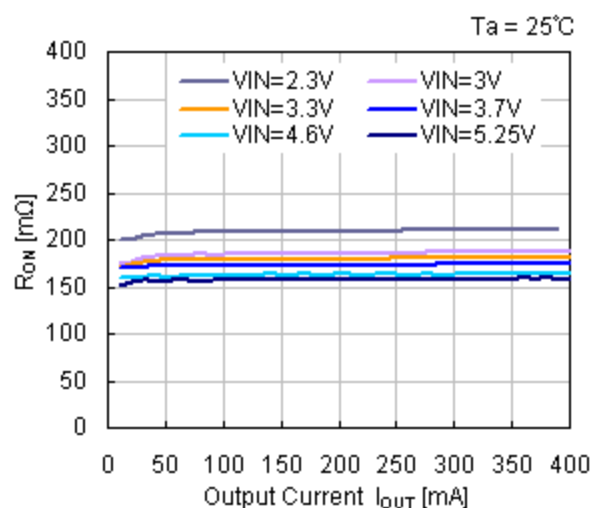

R5550K001A

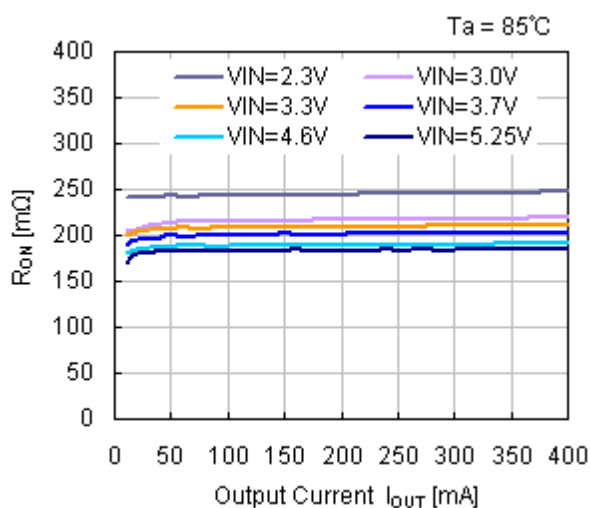

13) Inrush Current vs. Output Capacitor ( $C_{IN}=NONE$ )

R5550K001A

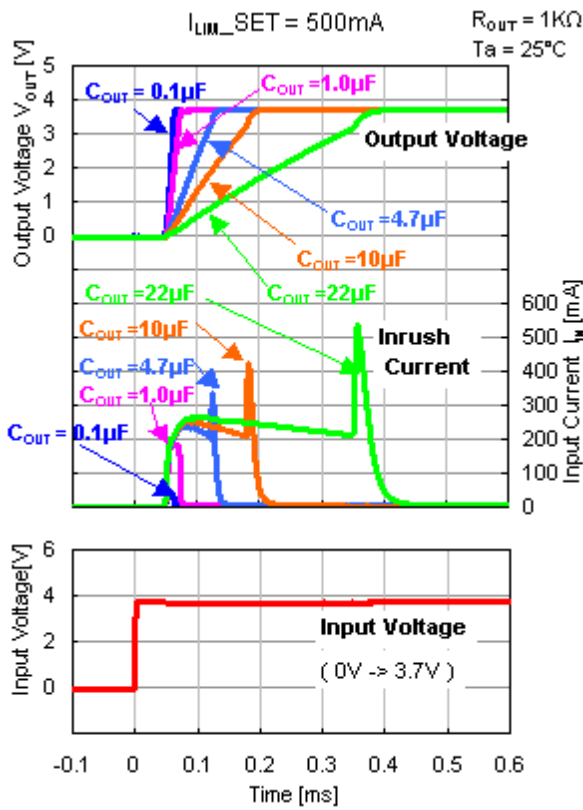

R5550K001A

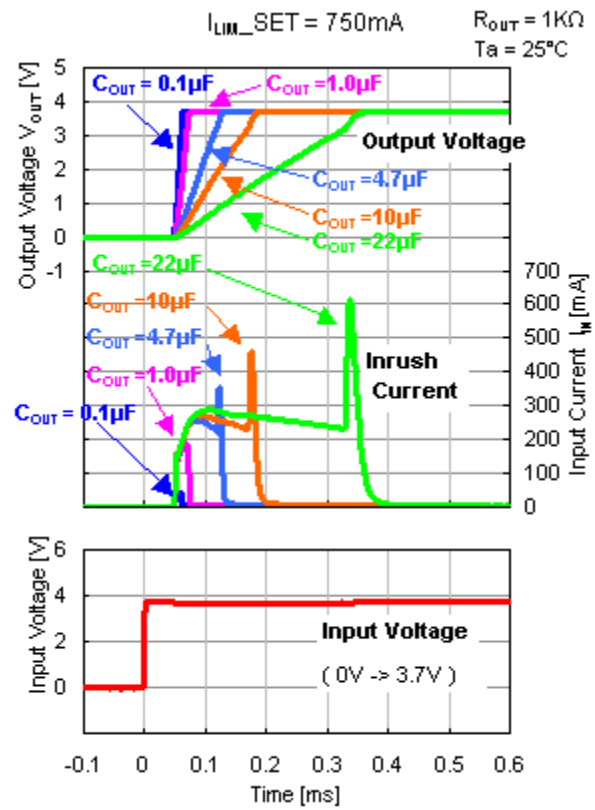

R5550K001A

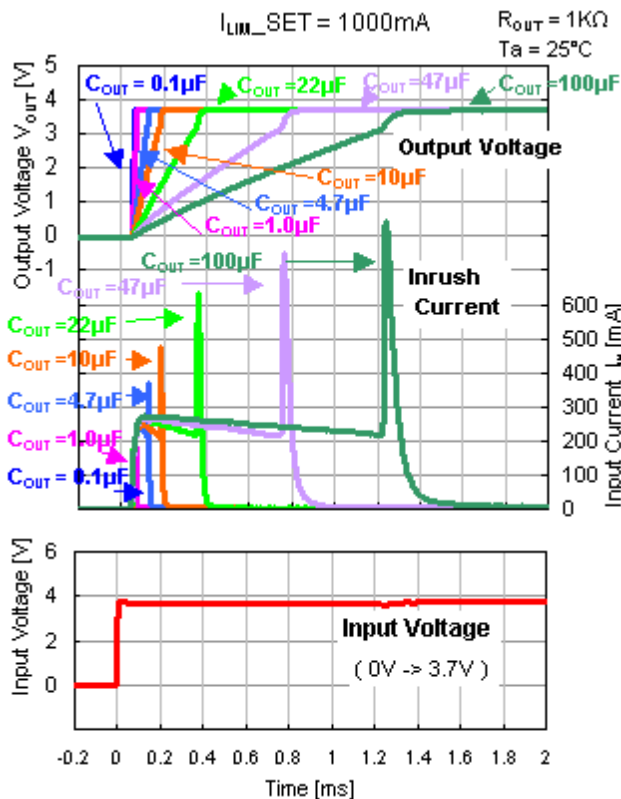

14) Inrush Current vs. Output Capacitor ( $C_{IN}=NONE$ ,  $C_{OUT}=1\mu F$ )  
**R5550K001A**

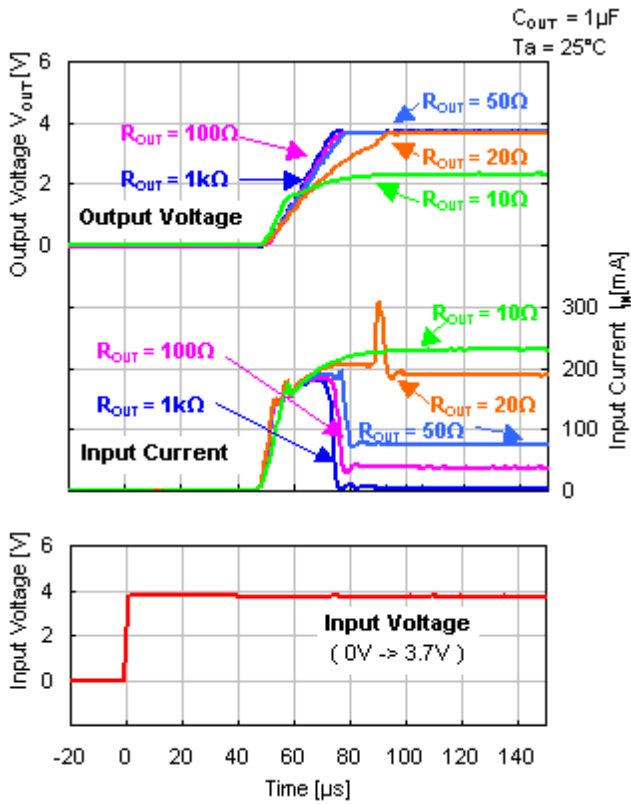

15) Output Rise Time vs. Input Voltage  
**R5550K001A**

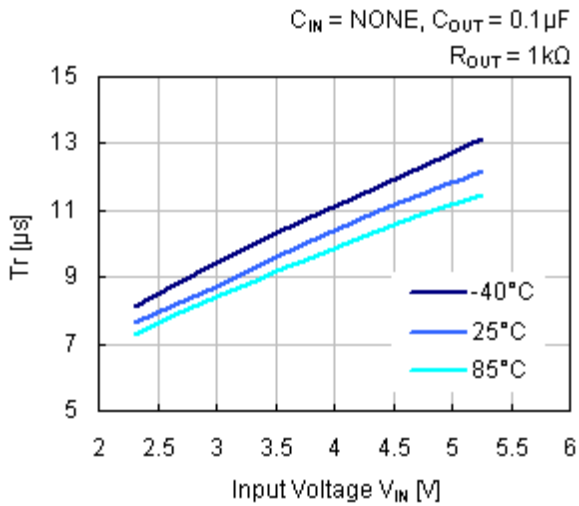

16) Output Delay Time vs. Input Voltage  
**R5550K001A**

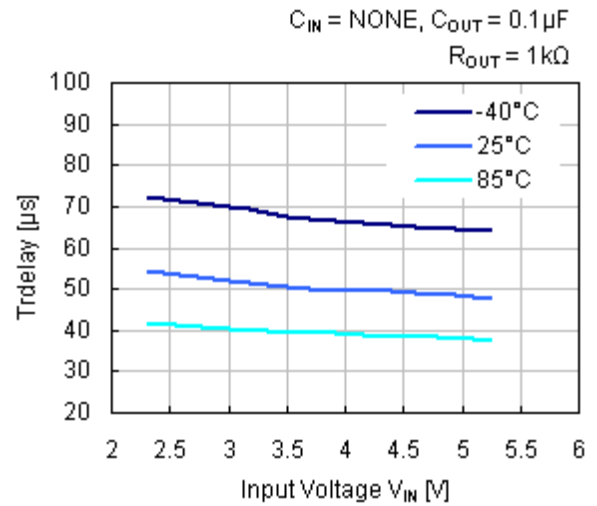

17) Output Rise Time + Output Delay Time vs. Input Voltage

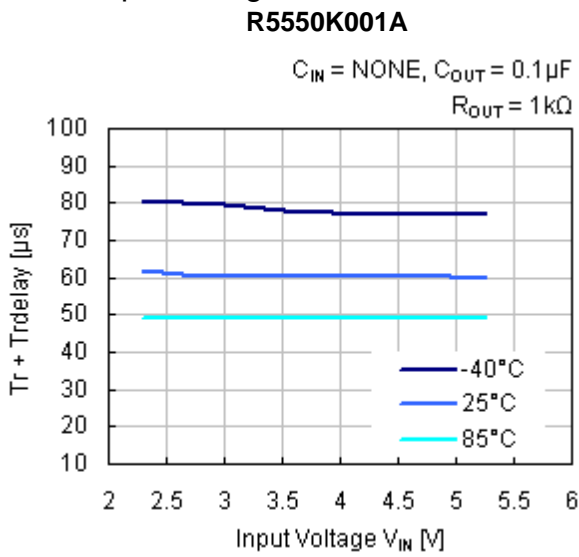

18)  $V_{SENSE}$  Detector Threshold vs. Temperature

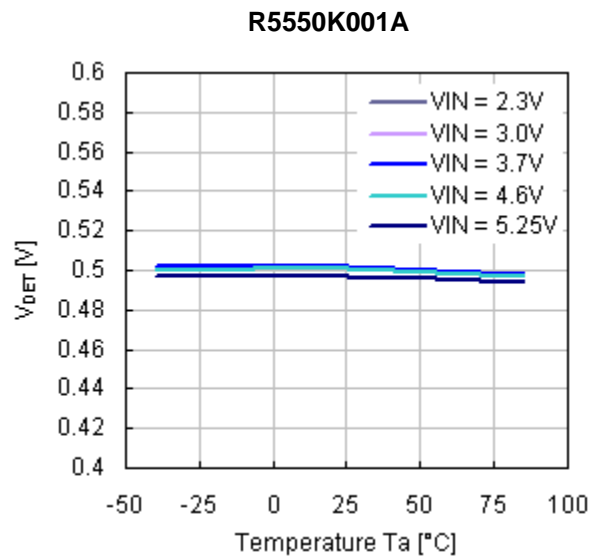

19)  $V_{SENSE}$  Released Voltage vs. Temperature

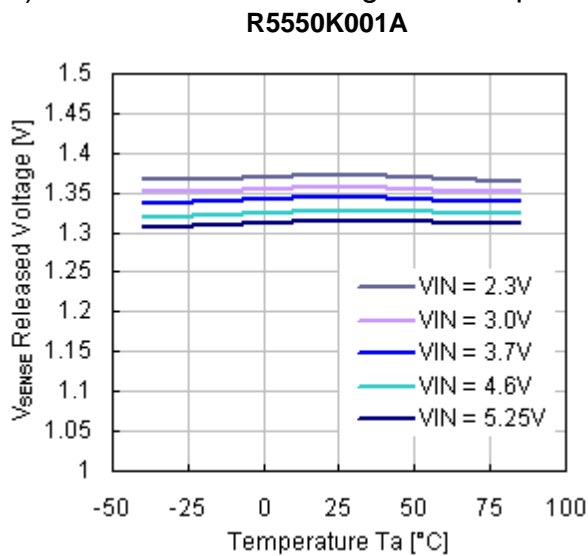

20)  $V_{SENSE}$  Hysteresis vs. Temperature

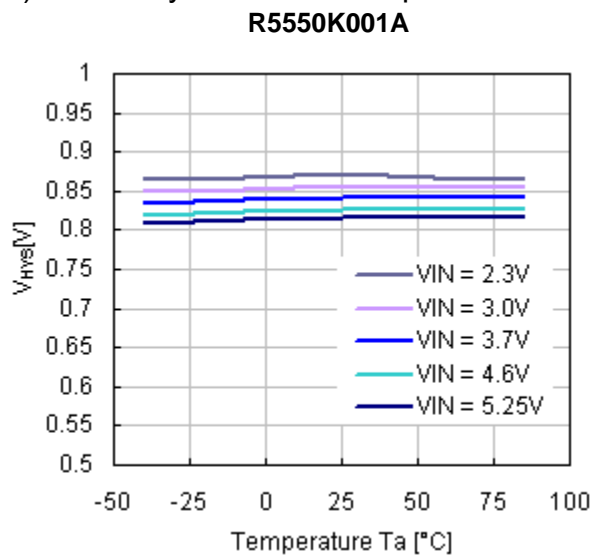

21)  $V_{SENSE}$  Detector Threshold vs. Input Voltage

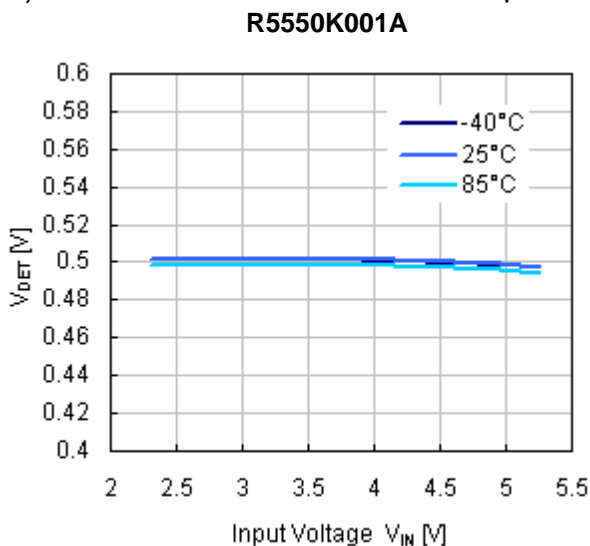

22)  $V_{SENSE}$  Released Voltage vs. Input Voltage

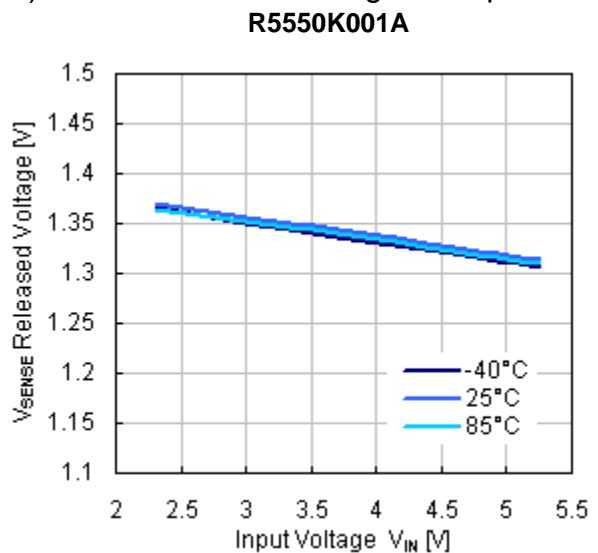

23)  $V_{SENSE}$  Hysterisis vs. Input Voltage  
R5550K001A

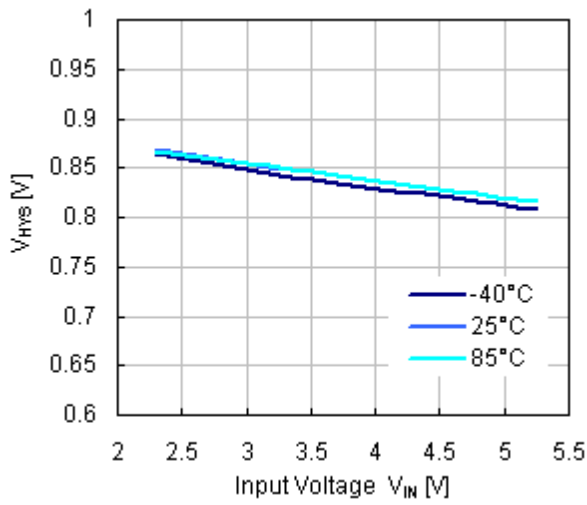

24) UVLO Released Voltage vs. Temperature  
R5550K001A

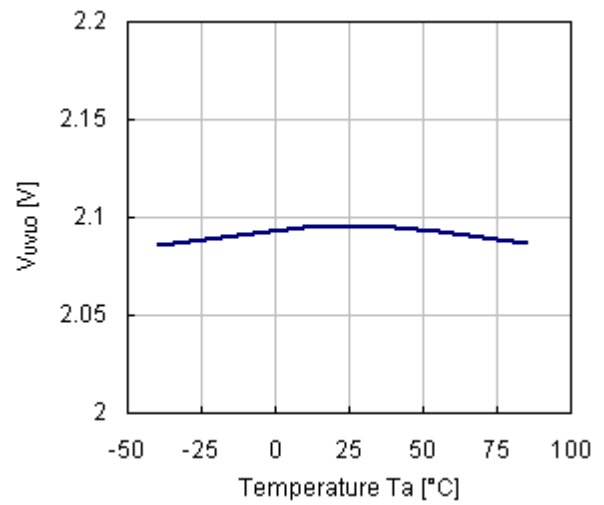

25) UVLO Hysterisis vs. Temperature  
R5550K001A

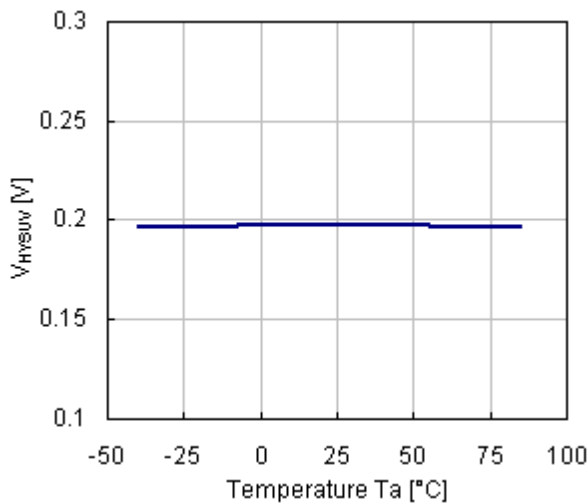

26) Supply Current at UVLO Detected vs. Temperature  
R5550K001A

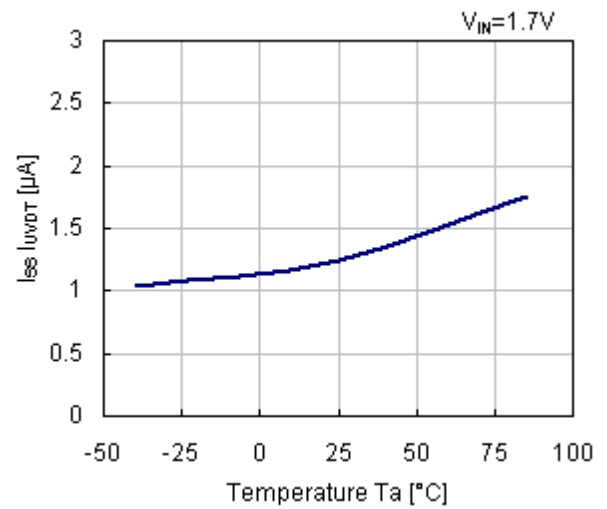

27) Limit Ignoring Time1 vs. Temperature  
R5550K001A

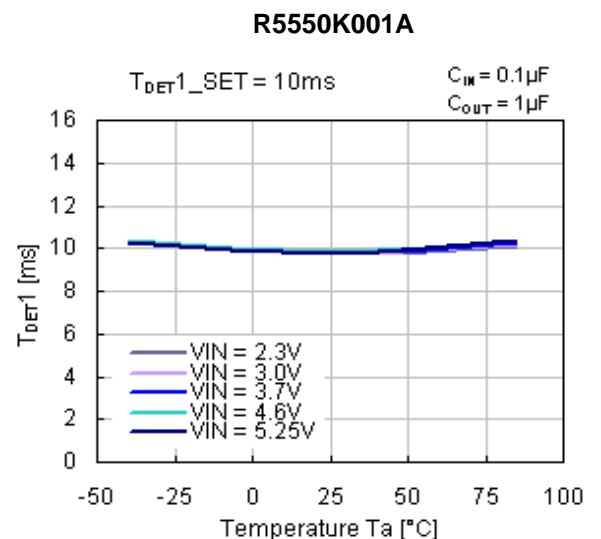
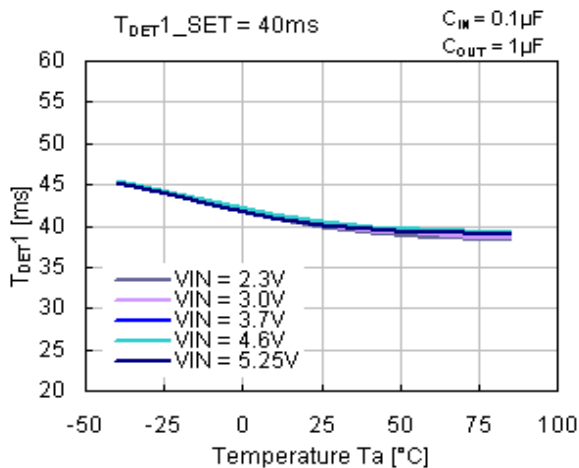

**R5550K001A**

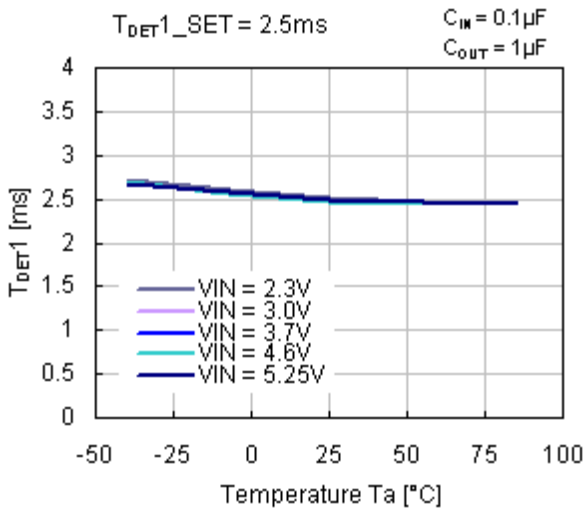

28) Limit Ignoring Time1 vs. Input Voltage

**R5550K001A**

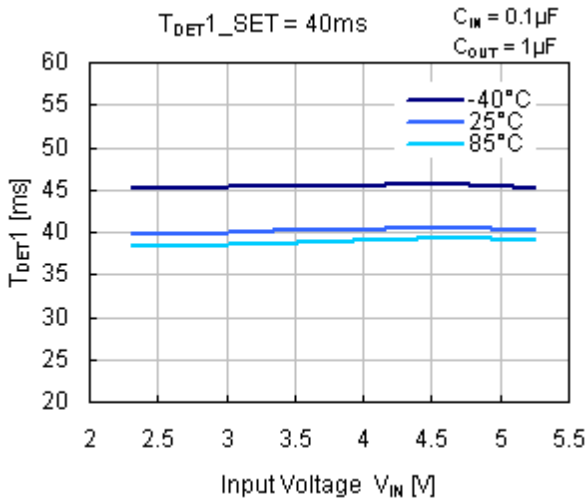

**R5550K001A**

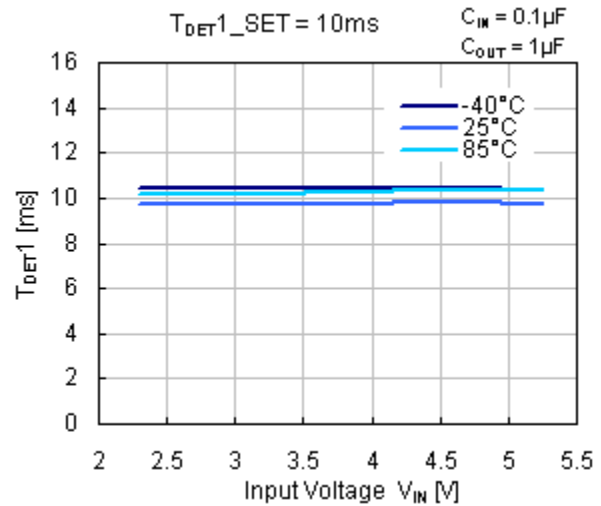

**R5550K001A**

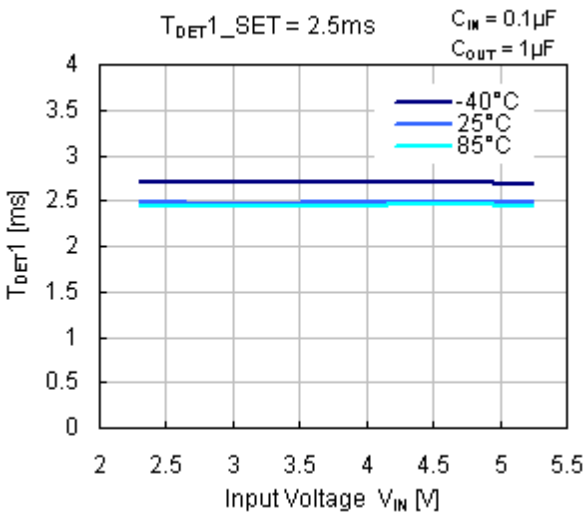

29) Limit Ignoring Time 2 vs. Temperature

R5550K001A

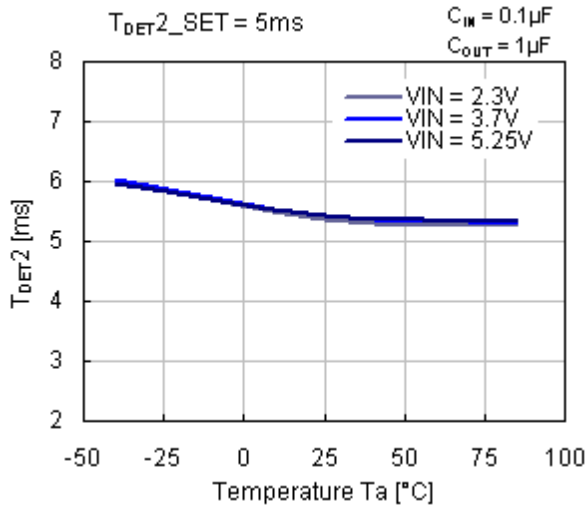

R5550K001A

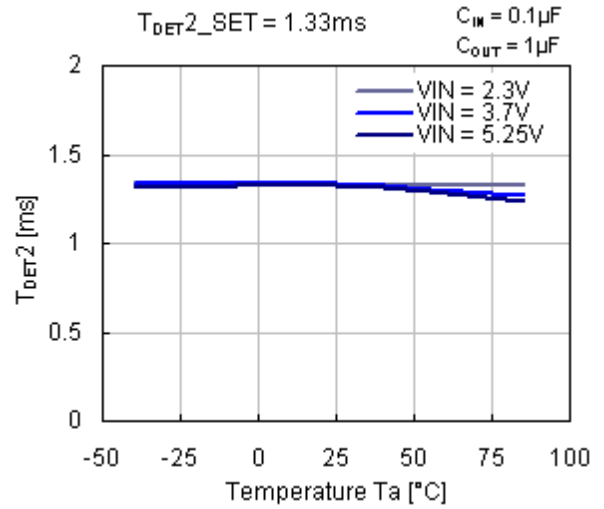

R5550K001A

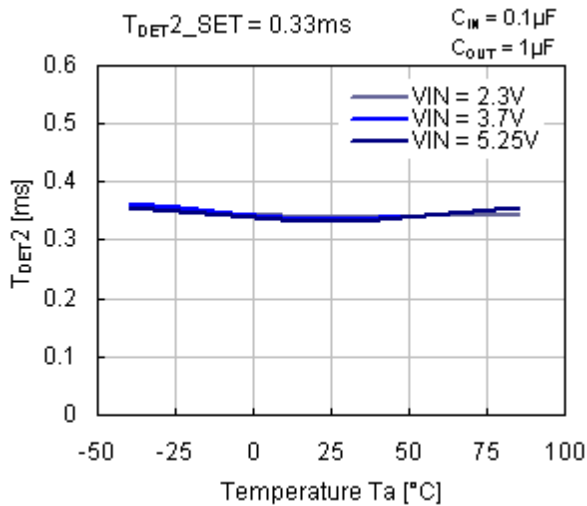

30) Limit Ignoring Time2 vs. Input Voltage

R5550K001A

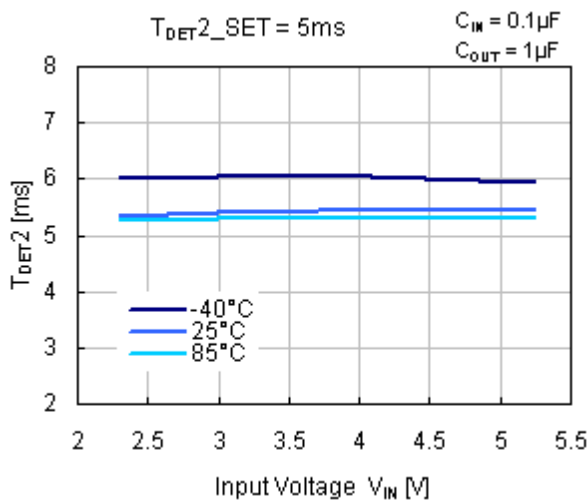

R5550K001A

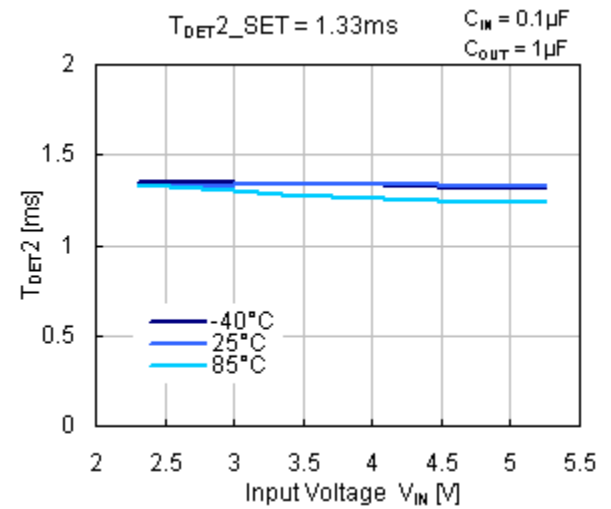

**R5550K001A**

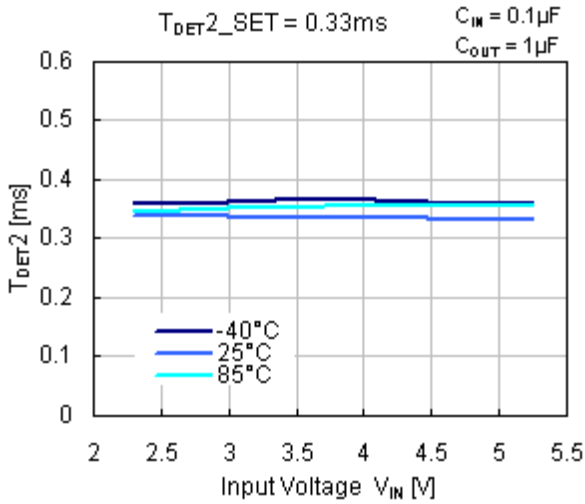

31) OFF Time1 vs. Temperature

**R5550K001A**

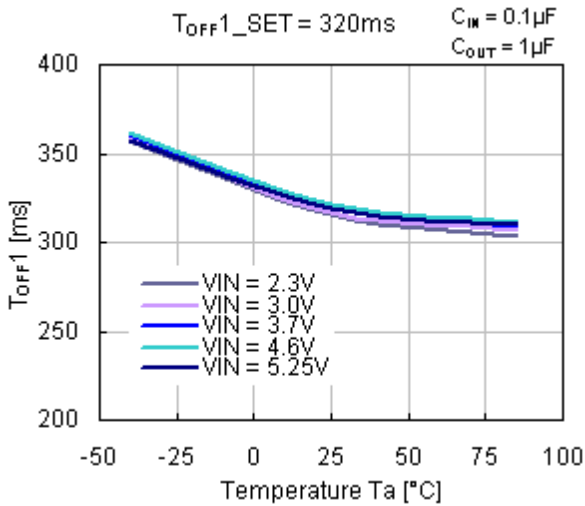

**R5550K001A**

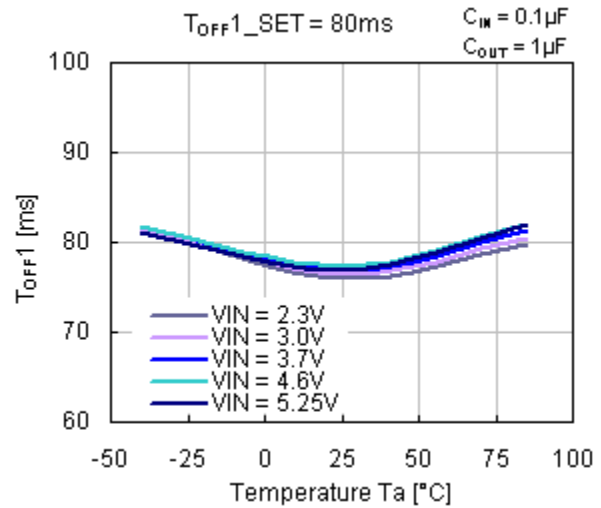

**R5550K001A**

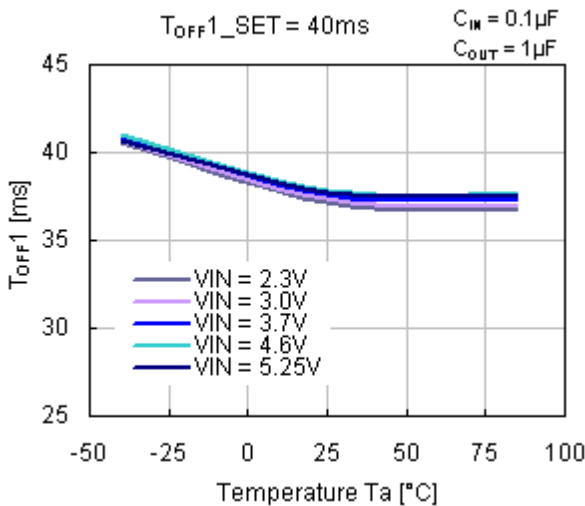



## 32) ON Time1 vs. Temperature

## R5550K001A

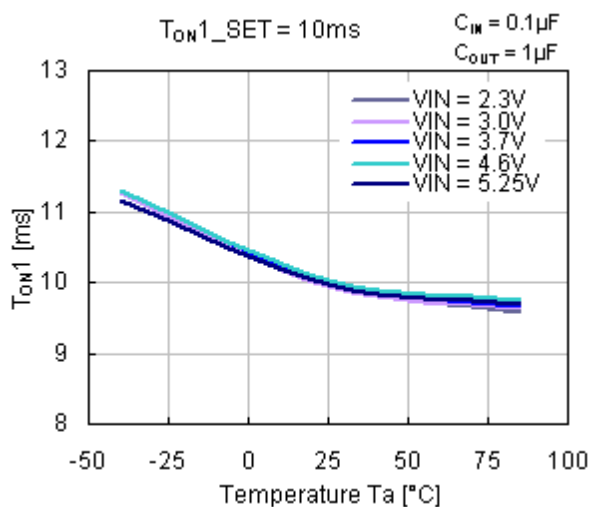

## R5550K001A

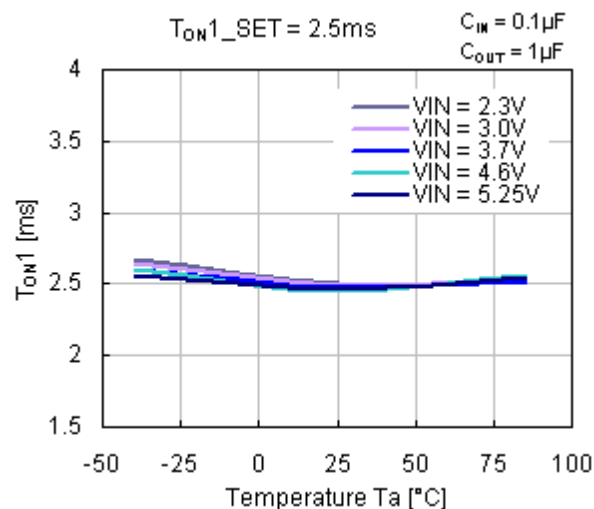

## R5550K001A

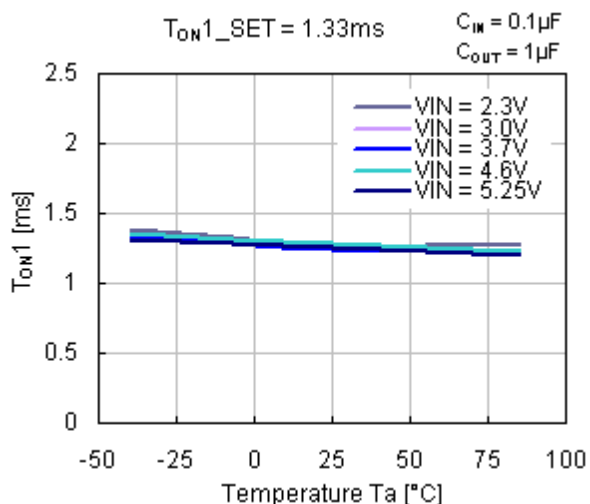

## 33) OFF Time2 vs. Temperature

## R5550K001A

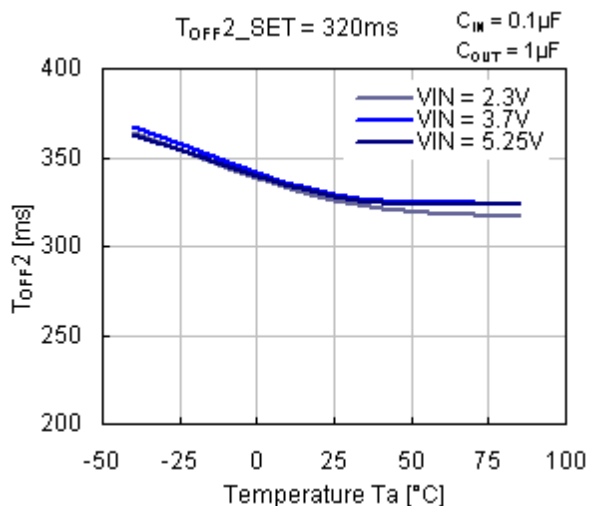

## R5550K001A

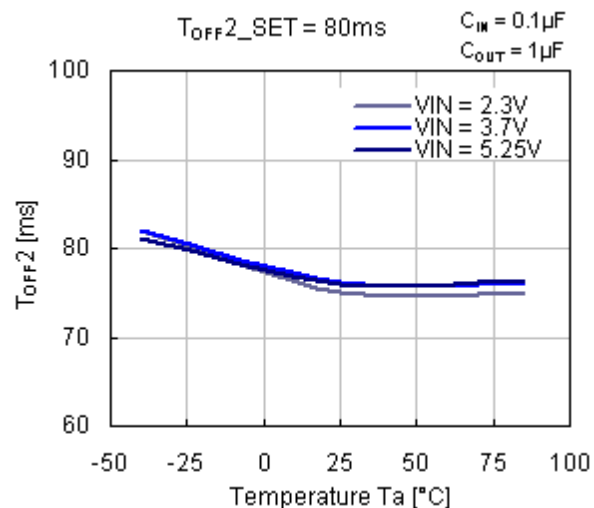

**R5550K001A**

$T_{OFF2\_SET} = 20ms$   $C_{IN} = 0.1\mu F$   
 $C_{OUT} = 1\mu F$

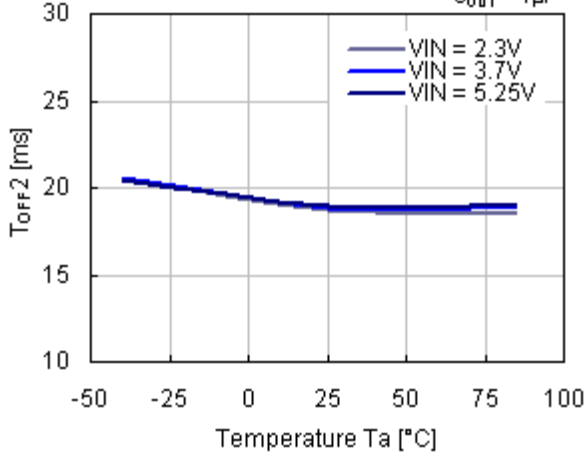

34) ON Time2 vs. Temperature

**R5550K001A**

$T_{ON2\_SET} = 5ms$   $C_{IN} = 0.1\mu F$   
 $C_{OUT} = 1\mu F$

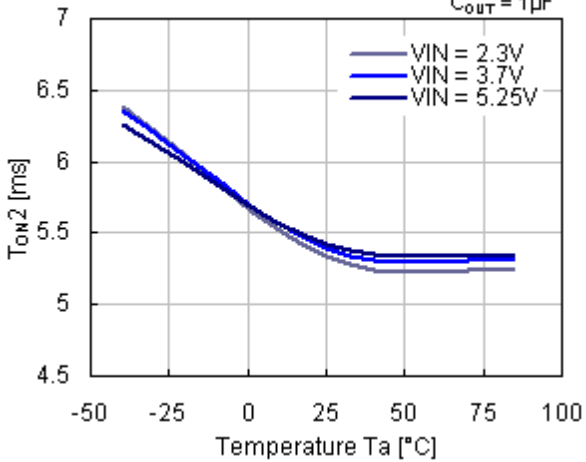

**R5550K001A**

$T_{ON2\_SET} = 1.33ms$   $C_{IN} = 0.1\mu F$   
 $C_{OUT} = 1\mu F$

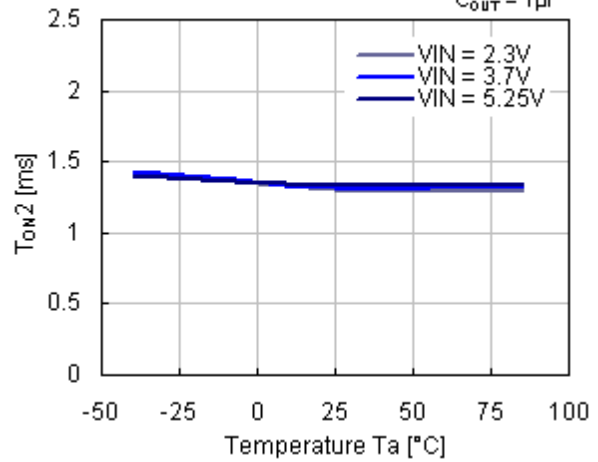

**R5550K001A**

$T_{ON2\_SET} = 0.33ms$   $C_{IN} = 0.1\mu F$   
 $C_{OUT} = 1\mu F$

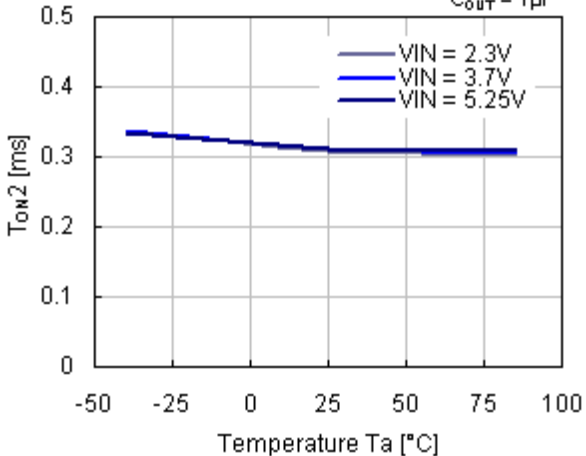

35) Operation Waveform with SENSE Pin

R5550K001A

$T_{DET1\_SET} = 10ms$   
 $T_{OFF1\_SET} = 80ms$   
 $T_{ON1\_SET} = 2.5ms$

$R_{OUT} = 1k\Omega$   
 $C_{IN} = NONE, C_{OUT} = NONE$

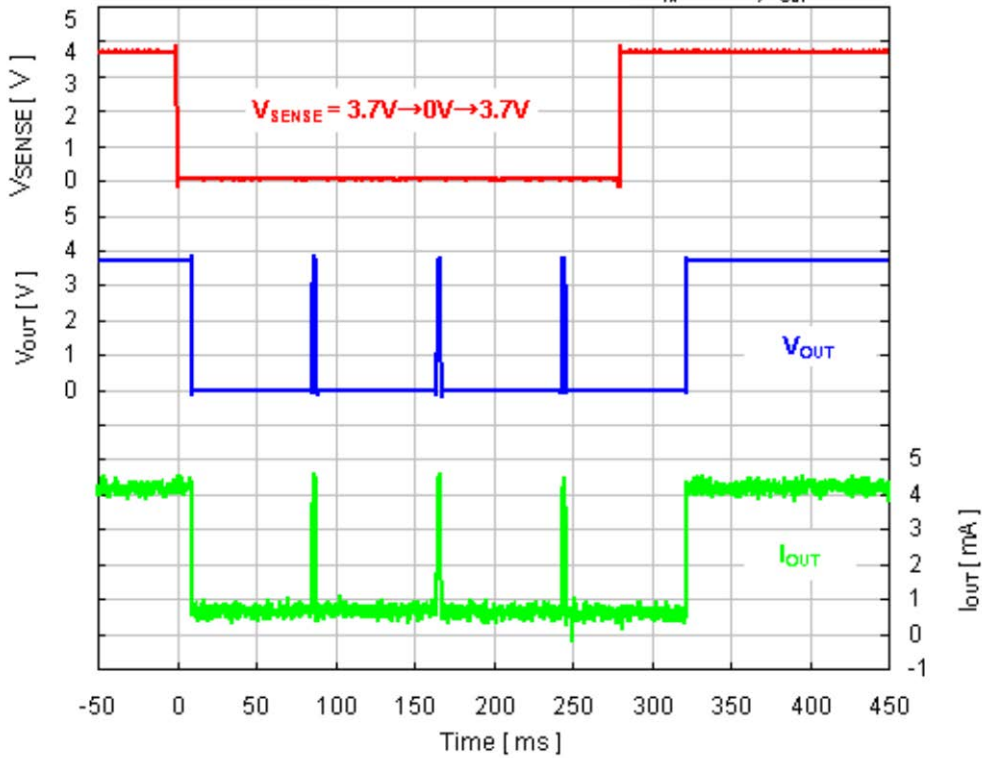

36) Short-Protection-Circuit Transient Response

R5550K001A

$V_{IN} = 3.7V, T_a = 25^\circ C$   
 $C_{IN} = 1\mu F, C_{OUT} = NONE$

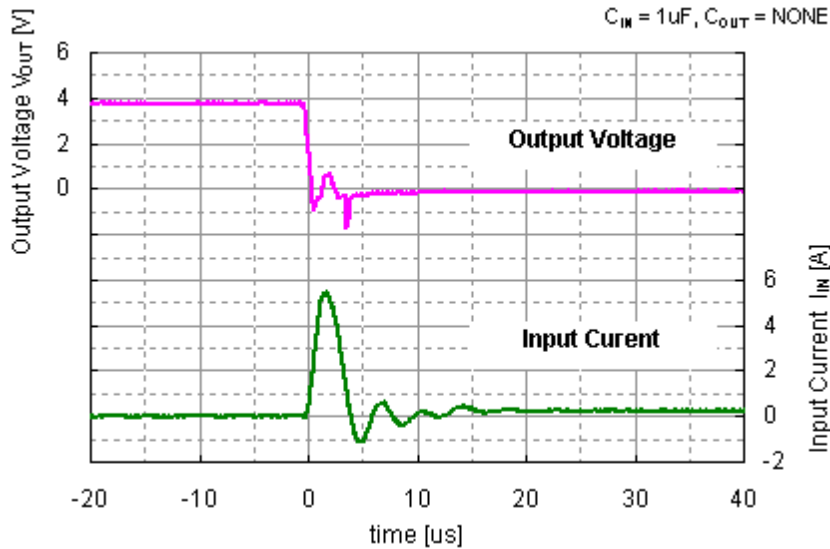



1. The products and the product specifications described in this document are subject to change or discontinuation of production without notice for reasons such as improvement. Therefore, before deciding to use the products, please refer to Ricoh sales representatives for the latest information thereon.
2. The materials in this document may not be copied or otherwise reproduced in whole or in part without prior written consent of Ricoh.
3. Please be sure to take any necessary formalities under relevant laws or regulations before exporting or otherwise taking out of your country the products or the technical information described herein.
4. The technical information described in this document shows typical characteristics of and example application circuits for the products. The release of such information is not to be construed as a warranty of or a grant of license under Ricoh's or any third party's intellectual property rights or any other rights.
5. The products listed in this document are intended and designed for use as general electronic components in standard applications (office equipment, telecommunication equipment, measuring instruments, consumer electronic products, amusement equipment etc.). Those customers intending to use a product in an application requiring extreme quality and reliability, for example, in a highly specific application where the failure or misoperation of the product could result in human injury or death (aircraft, spacevehicle, nuclear reactor control system, traffic control system, automotive and transportation equipment, combustion equipment, safety devices, life support system etc.) should first contact us.
6. We are making our continuous effort to improve the quality and reliability of our products, but semiconductor products are likely to fail with certain probability. In order to prevent any injury to persons or damages to property resulting from such failure, customers should be careful enough to incorporate safety measures in their design, such as redundancy feature, fire containment feature and fail-safe feature. We do not assume any liability or responsibility for any loss or damage arising from misuse or inappropriate use of the products.
7. Anti-radiation design is not implemented in the products described in this document.
8. The X-ray exposure can influence functions and characteristics of the products. Confirm the product functions and characteristics in the evaluation stage.
9. WLCSP products should be used in light shielded environments. The light exposure can influence functions and characteristics of the products under operation or storage.
10. There can be variation in the marking when different AOI (Automated Optical Inspection) equipment is used. In the case of recognizing the marking characteristic with AOI, please contact Ricoh sales or our distributor before attempting to use AOI.
11. Please contact Ricoh sales representatives should you have any questions or comments concerning the products or the technical information.



**Ricoh is committed to reducing the environmental loading materials in electrical devices with a view to contributing to the protection of human health and the environment.**

Ricoh has been providing RoHS compliant products since April 1, 2006 and Halogen-free products since April 1, 2012.

**RICOH** RICOH ELECTRONIC DEVICES CO., LTD.

<https://www.e-devices.ricoh.co.jp/en/>

#### Sales & Support Offices

##### **Ricoh Electronic Devices Co., Ltd.**

##### **Shin-Yokohama Office (International Sales)**

2-3, Shin-Yokohama 3-chome, Kohoku-ku, Yokohama-shi, Kanagawa, 222-8530, Japan  
Phone: +81-50-3814-7687 Fax: +81-45-474-0074

##### **Ricoh Americas Holdings, Inc.**

675 Campbell Technology Parkway, Suite 200 Campbell, CA 95008, U.S.A.  
Phone: +1-408-610-3105

##### **Ricoh Europe (Netherlands) B.V.**

##### **Semiconductor Support Centre**

Prof. W.H. Keesomlaan 1, 1183 DJ Amstelveen, The Netherlands  
Phone: +31-20-5474-309

##### **Ricoh International B.V. - German Branch**

##### **Semiconductor Sales and Support Centre**

Oberrather Strasse 6, 40472 Düsseldorf, Germany  
Phone: +49-211-6546-0

##### **Ricoh Electronic Devices Korea Co., Ltd.**

3F, Haesung Bldg, 504, Teheran-ro, Gangnam-gu, Seoul, 135-725, Korea  
Phone: +82-2-2135-5700 Fax: +82-2-2051-5713

##### **Ricoh Electronic Devices Shanghai Co., Ltd.**

Room 403, No.2 Building, No.690 Bibo Road, Pu Dong New District, Shanghai 201203,  
People's Republic of China  
Phone: +86-21-5027-3200 Fax: +86-21-5027-3299

##### **Ricoh Electronic Devices Shanghai Co., Ltd.**

##### **Shenzhen Branch**

1205, Block D (Jinlong Building), Kingkey 100, Hongbao Road, Luohu District,  
Shenzhen, China  
Phone: +86-755-8348-7600 Ext 225

##### **Ricoh Electronic Devices Co., Ltd.**

##### **Taipei office**

Room 109, 10F-1, No.51, Hengyang Rd., Taipei City, Taiwan (R.O.C.)  
Phone: +886-2-2313-1621/1622 Fax: +886-2-2313-1623