

---

## N-channel Load Switch IC

---

NO. EA-268-111028

### OUTLINE

The R5540 series are N-channel Load Switch ICs with the low supply current, Typ. 9 $\mu$ A. By using an Nch transistor as a driver transistor, the features of low on resistance and the reverse current protection at off state are realized in these ICs. The gate voltage of the N-channel transistor is supplied from the internal step-up circuit. The R5540 is an ideal switch to supply the power from the secondary power source such as the output of a step-down DC/DC to the load circuit. Since the package for the R5540 is the ultra small-sized DFN(PLP)1010-4F, high density mounting on board is possible.

### FEATURES

- Built-in an N-channel MOSFET
- Input Voltage Range ..... 0.75V to 3.6V (Code 002)  
..... 0.8V to 3.6V (Code 004)
- Supply Current at Operation ( $I_{OUT}=0mA$ ) ..... Typ. 9 $\mu$ A
- Supply Current at Standby Mode ..... Typ. 0.7 $\mu$ A
- Switch On Resistance ..... Typ. 120m $\Omega$  ( $V_{IN}=1.2V$ )
- Output Current ..... Min. 200mA/ Min. 450mA
- Package ..... DFN(PLP)1010-4F
- Built-in Over- current Sensing Circuit ..... TYP. 350mA/ TYP. 700mA
- Built-in Soft-start function

### APPLICATION

- For secondary power source for electrical appliances such as mobile communication equipments, cameras, VCRs and Camcorders.

## BLOCK DIAGRAMS

R5540KxxxB

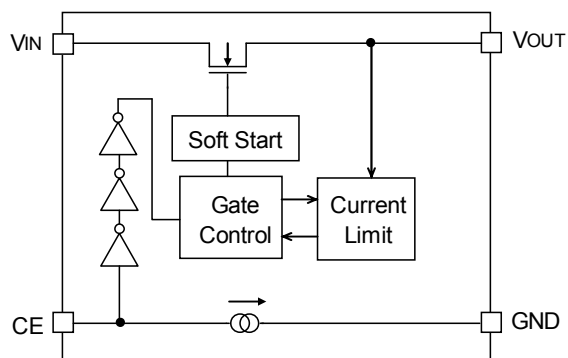

R5540KxxxC

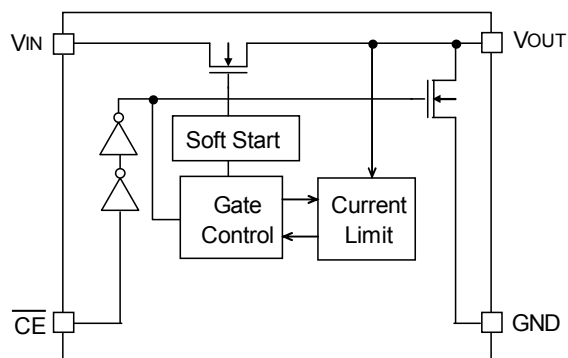

R5540KxxxD

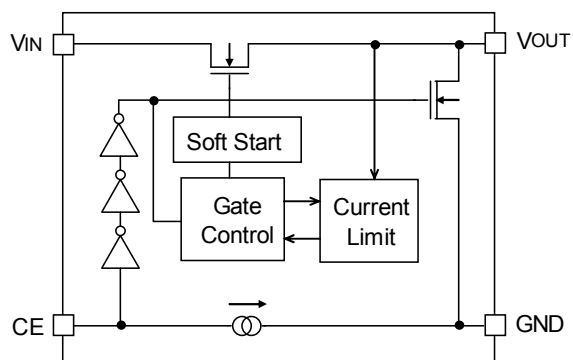

## SELECTION GUIDE

The output current value, the auto-discharge function and the polarity of CE pin from "L" active, "H" active are selectable at the user's request.

Product Name	Package	Quantity per Reel	Pb Free	Halogen Free
R5540Kxxx*-TR	DFN(PLP)1010-4F	10,000pcs	Yes	Yes

xxx: The output current value can be designated by the following codes.

002: Output Current (200mA)

004: Output Current (450mA)

\*: Auto-discharge function at off state and the polarity of CE pin are option as follows.

B: "H" active, without auto-discharge function at off state

C: "L" active, with auto-discharge function at off state

D: "H" active, with auto-discharge function at off state

## PIN CONFIGURATIONS

### • DFN(PLP)1010-4F

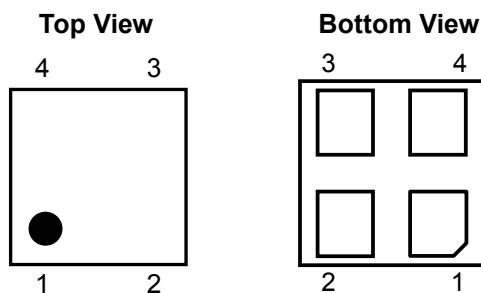

## PIN DESCRIPTION

### ● R5540K : DFN(PLP)1010-4F

Pin No	Symbol	Pin Description
1	GND	Ground Pin
2	$\overline{CE}$ / CE	Chip Enable Pin ("L" Active / "H" Active)
3	$V_{IN}$	Input Pin
4	$V_{OUT}$	Output Pin

## ABSOLUTE MAXIMUM RATINGS

Symbol	Item	Rating	Unit
$V_{IN}$	Input Voltage	-0.3 to 5.0	V
$V_{CE}$	Input Voltage ( $\overline{CE}$ / CE Pin)	-0.3 to 5.0	V
$V_{OUT}$	Output Voltage	-0.3 to 5.0	V
$I_{OUT}$	Output Current	Internally limited	mA
$P_D$	Power Dissipation (Standard Test Land Pattern)*	300	mW
$T_a$	Ambient Temperature	-40 to 85	°C
$T_{stg}$	Storage Temperature	-55 to 125	°C

\*) For Power Dissipation, please refer to Power Dissipation to be described.

### ABSOLUTE MAXIMUM RATINGS

Electronic and mechanical stress momentarily exceeded absolute maximum ratings may cause the permanent damages and may degrade the life time and safety for both device and system using the device in the field. The functional operation at or over these absolute maximum ratings is not assured.

### RECOMMENDED OPERATING CONDITIONS (ELECTRICAL CHARACTERISTICS)

All of electronic equipment should be designed that the mounted semiconductor devices operate within the recommended operating conditions. The semiconductor devices cannot operate normally over the recommended operating conditions, even if when they are used over such conditions by momentary electronic noise or surge. And the semiconductor devices may receive serious damage when they continue to operate over the recommended operating conditions.

## ELECTRICAL CHARACTERISTICS

$V_{IN} = 0.75$  to  $3.60V$ (Code 002) ,  $0.80$  to  $3.60V$ (Code 004),  $C_{IN} = 1\mu F$ ,  $C_{OUT} = \text{None}$ , unless otherwise noted.

The specification in surrounded by   is guaranteed by design at all temperature range,  $-40^{\circ}C \leq T_a \leq 85^{\circ}C$ .

R5540Kxxxx

( $T_a=25^{\circ}C$ )

Symbol	Item	Conditions		Min.	Typ.	Max.	Unit
$V_{IN}$	Input Voltage	Code 002		0.75		3.60	V
		Code 004		0.80		3.60	
$R_{ON}$	Switch ON Resistance	Code 002	$V_{IN}=1.2V, I_{OUT}=200mA$		120	180	$m\Omega$
		Code 004	$V_{IN}=1.2V, I_{OUT}=450mA$				
$I_{OUT}$	Output Current	Code 002		<span style="border: 1px solid black; padding: 0 2px;">200</span>			mA
$I_{OUT}$	Output Current	Code 004		<span style="border: 1px solid black; padding: 0 2px;">450</span>			
$I_{SS}$	Supply Current	$I_{OUT}=0mA$ *Note1			9	40	$\mu A$
$I_{standby}$	Standby Current	$V_{OUT}=GND$ $V_{IN}=1.8V$ *Note2	$T_a=25^{\circ}C$		0.7		$\mu A$
			$T_a=85^{\circ}C$		5		
$I_{LIM}$	Current Limit	Code 002	$V_{IN}=1.2V$	200	350	500	mA
$I_{LIM}$	Current Limit	Code 004		450	700	1000	
$I_{SC}$	Short Current Limit	$V_{IN}=1.2V, V_{OUT}=0V$			50	100	mA
$I_{CE}$	$\overline{CE}$ Input Current	C version			0.4		$\mu A$
$I_{CEPD}$	CE Pull-down Current	B, D version			0.7		$\mu A$
$V_{CEH}$	CE Input Voltage "H"	$V_{IN}=2.5V$ to $3.6V$		<span style="border: 1px solid black; padding: 0 2px;">1.0</span>			V
		$V_{IN}=1.0V$ to $2.5V$		<span style="border: 1px solid black; padding: 0 2px;">0.9</span>			
		$V_{IN}=0.75V$ to $1.0V$		$V_{IN} \times 0.9$			
$V_{CEL}$	CE Input Voltage "L"	$V_{IN}=0.75V$ to $3.6V$				<span style="border: 1px solid black; padding: 0 2px;">0.4</span>	V
$R_{LOW}$	Auto-discharge Nch Tr. ON Resistance (Version. C, D)	$V_{IN}=1.2V$ *Note2			100		$\Omega$
$t_r$	Output Rise Time	$V_{IN}=1.2V, V_{OUT}=10\% \sim 90\%$ $C_{OUT}=0.1\mu F$			73		$\mu s$
$t_{sc}$	Short Current Response Time	$V_{OUT}=0V$			30		$\mu s$

All test categories were tested on the units under the pulse load condition ( $T_j \approx T_a = 25^{\circ}C$ ) except Short Current Response Time.

\*Note1  $\overline{CE} = L$  for "L" active,  $CE = H$  for "H" active

\*Note2  $\overline{CE} = H$  for "L" active,  $CE = L$  for "H" active

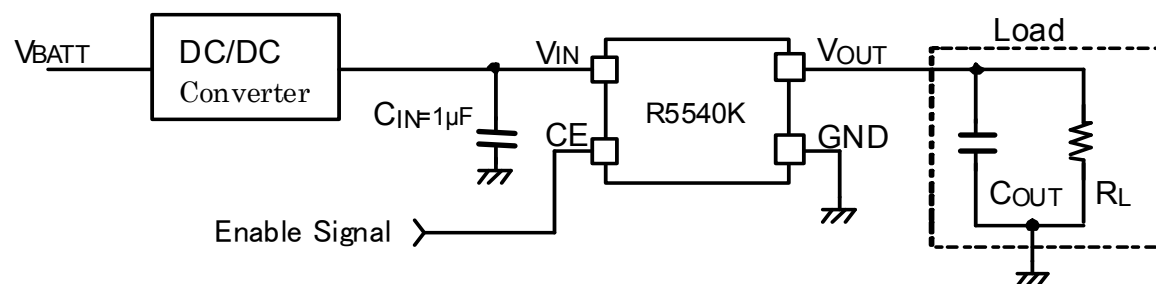
**TYPICAL APPLICATION**

Basically, the R5540K series do not require a bypass capacitor between  $V_{IN}$  and GND, however, considering the spike noise caused by the high side inductor at current limit, use 0.1µF or more capacitor as a bypass capacitor. More capacitance is also acceptable depending on the application.

## TYPICAL CHARACTERISTIC

1) Output Voltage vs. Output Current  $C_{IN}=1\mu F$ ,  $C_{OUT}=1\mu F$

R5540K002x

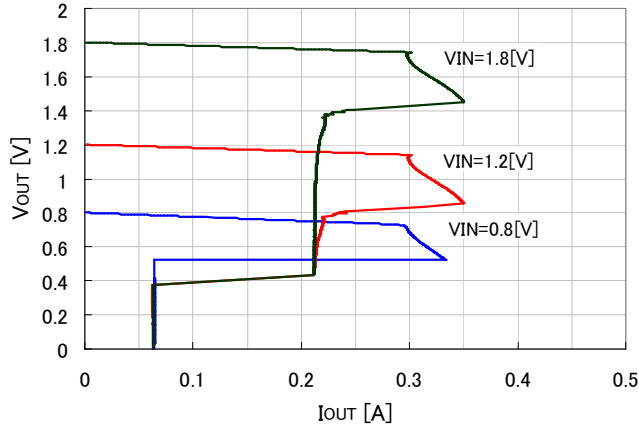

R5540K004x

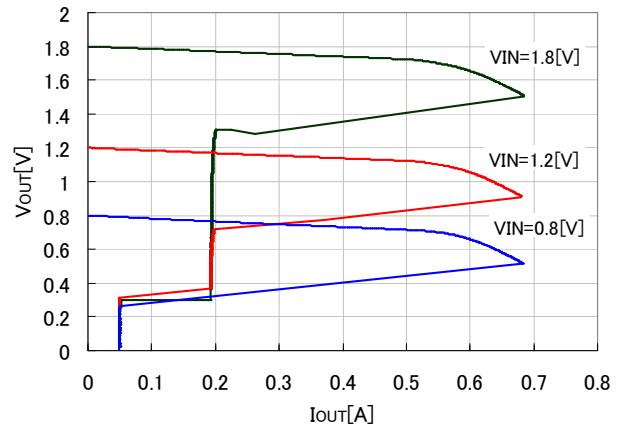

2) Turn on waveform (002x,  $V_{IN}=1.2V$ ,  $C_{IN}=1\mu F$ ,  $T_a=25^\circ C$ )

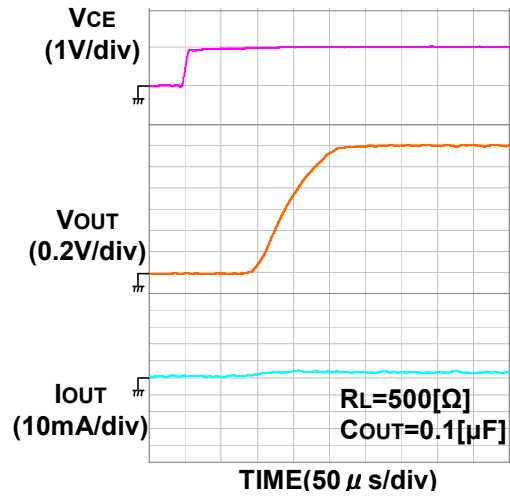
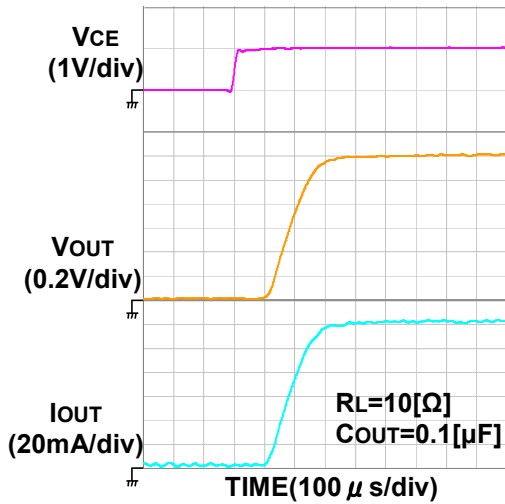

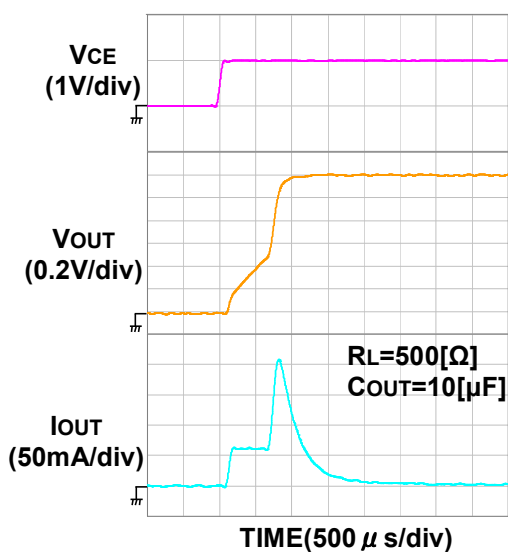
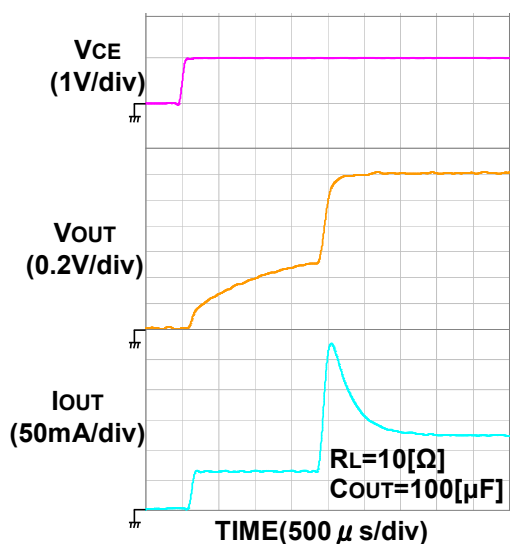
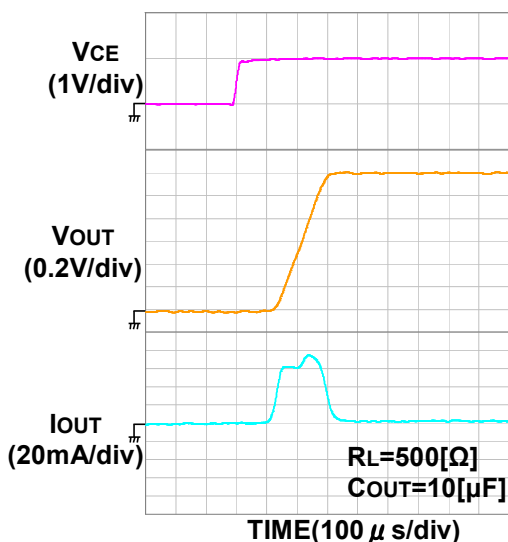
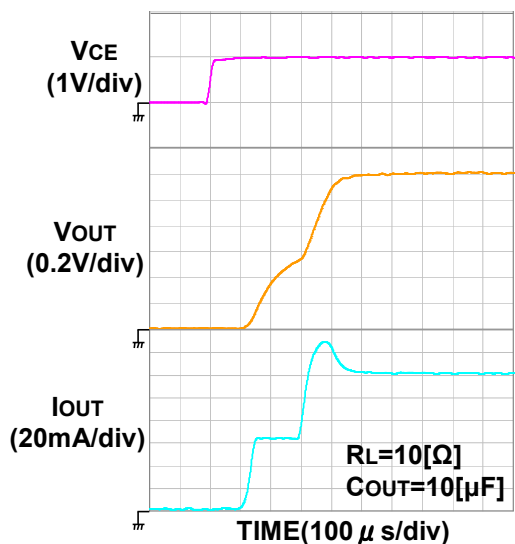
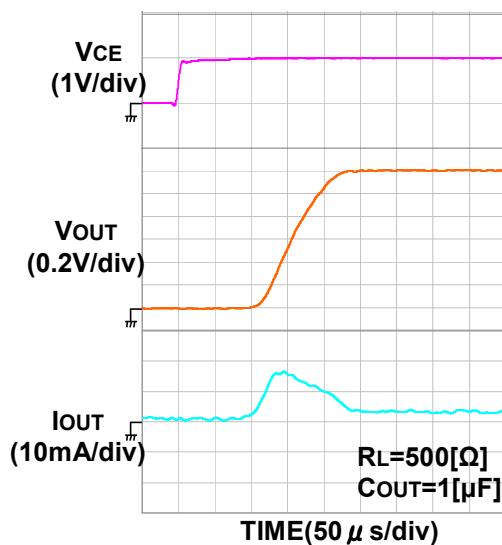
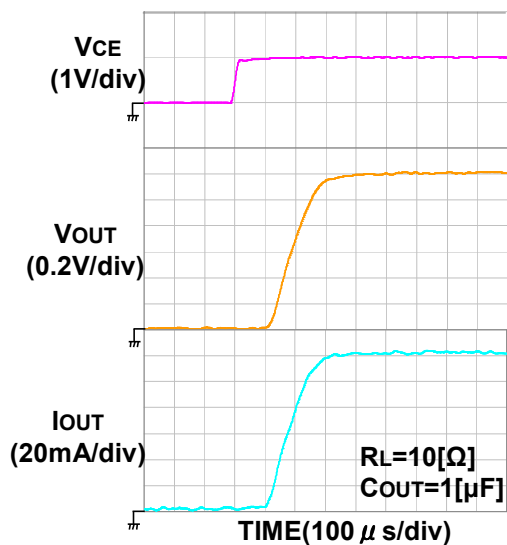



3) Inrush current vs. output capacitor (002x)

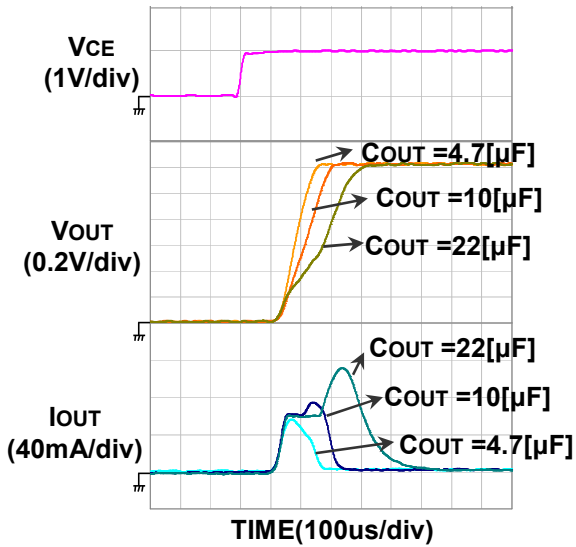

4) Input voltage vs. Turn-on speed

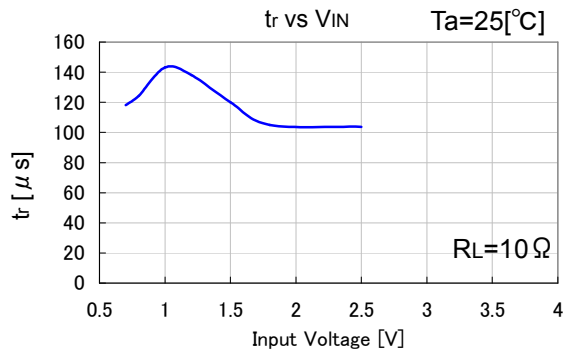

5) Supply current vs. Temperature

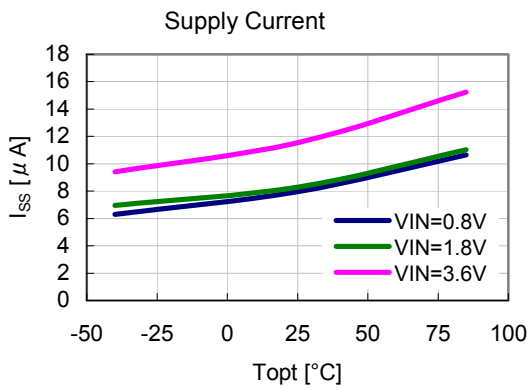

6) Standby current vs. Input voltage

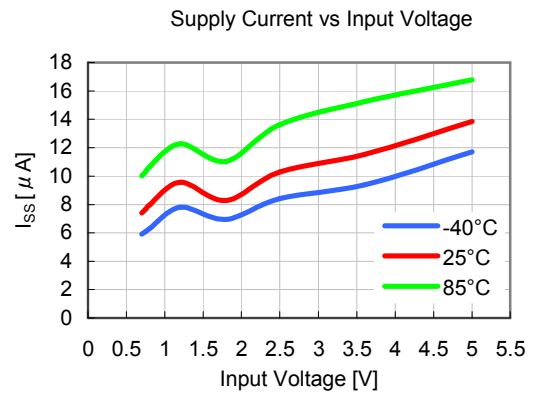

7) Standby Current vs. Temperature

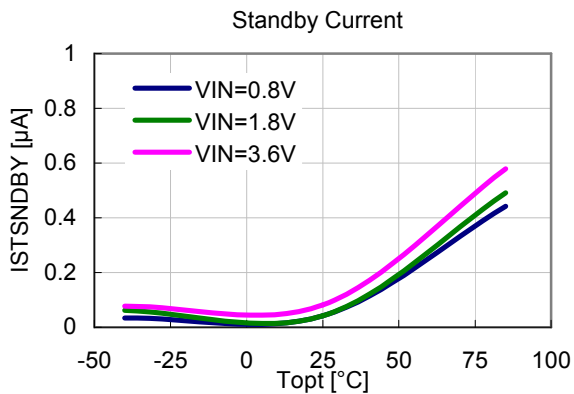

8) Standby current vs. Input voltage

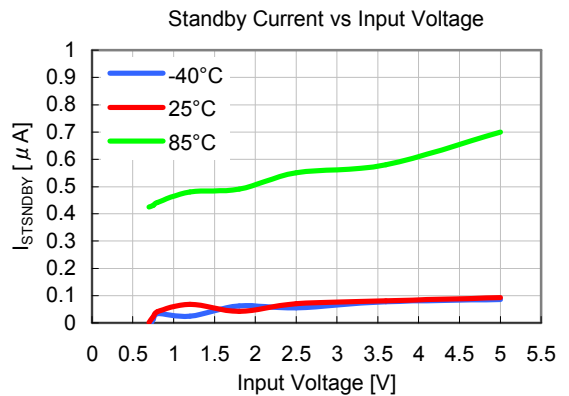

9) CE Input voltage "H" vs. Temperature

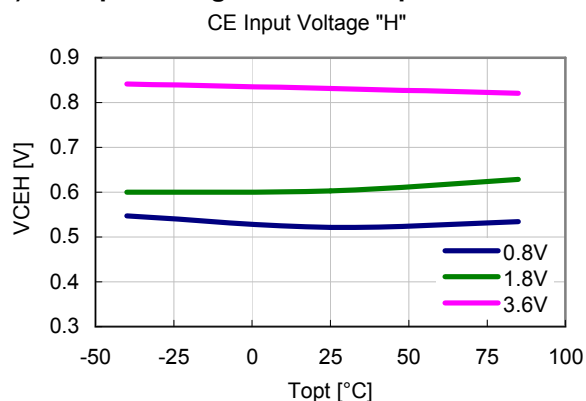

10) CE Input voltage "H" vs. VDD

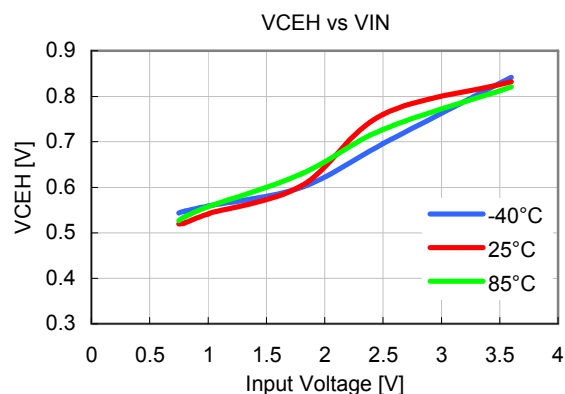

11) CE Input voltage "L" vs. Temperature

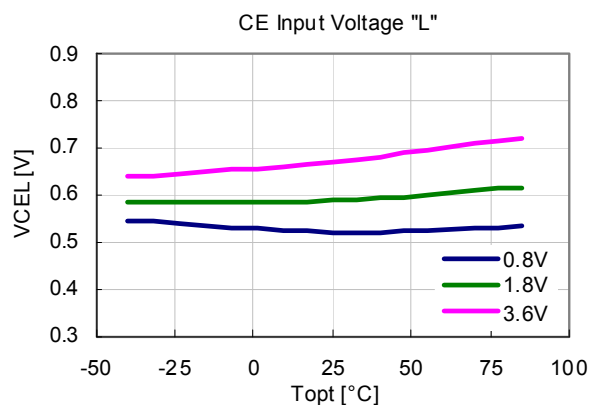

12) CE Input voltage "L" vs. VDD

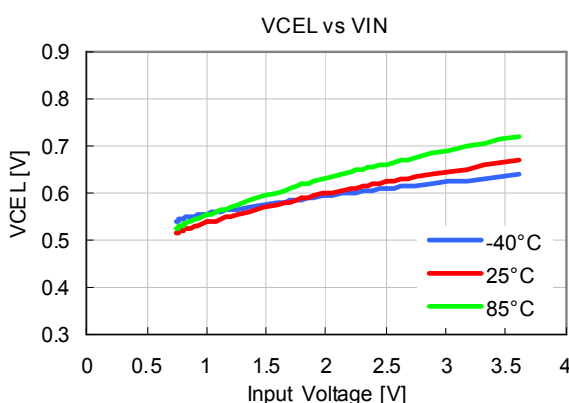

13) Short current limit vs. Temperature

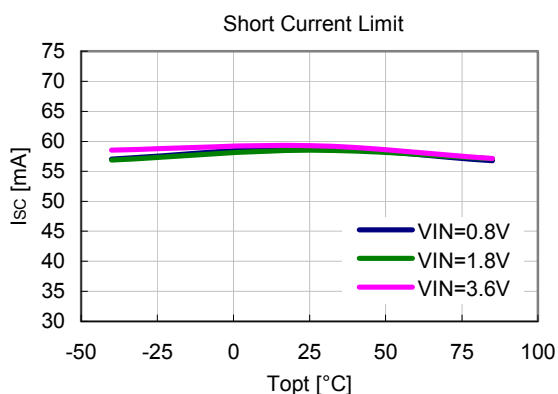

14) Short current limit vs. Input voltage

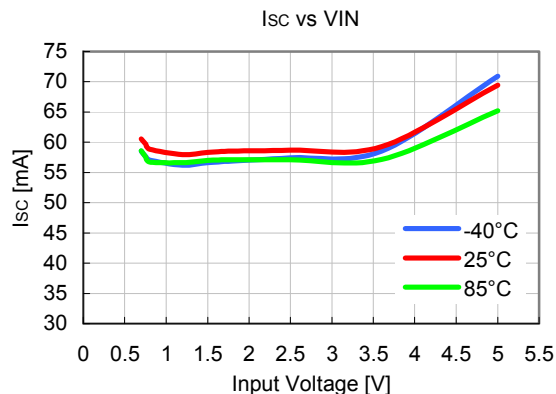

15) Switch on resistance vs. Temperature

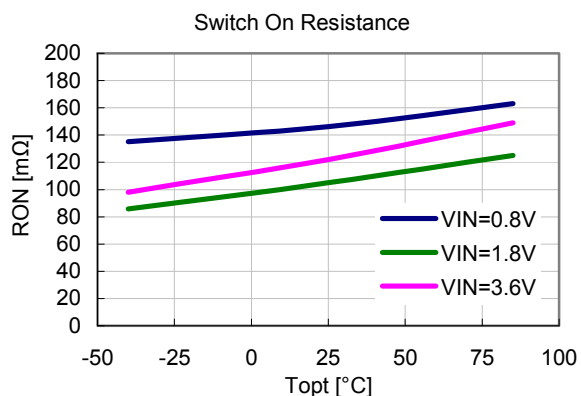

16) Switch on resistance vs. Input voltage

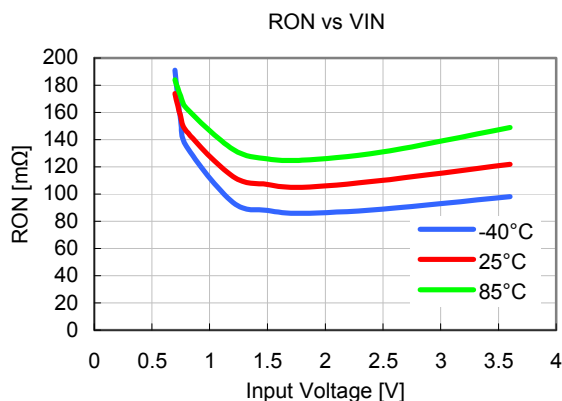

17) Output Rise time vs. Temperature

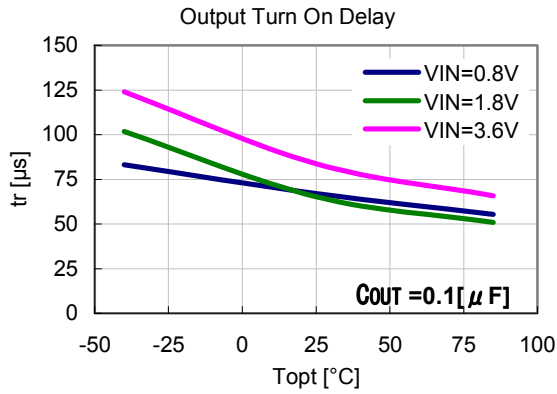

18) Output Rise time vs. Input voltage

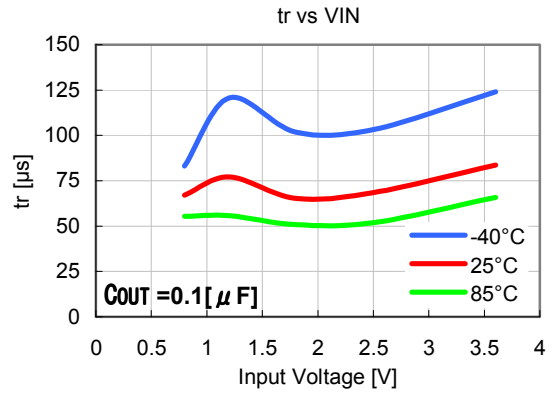

19) Output Fall time vs. Temperature

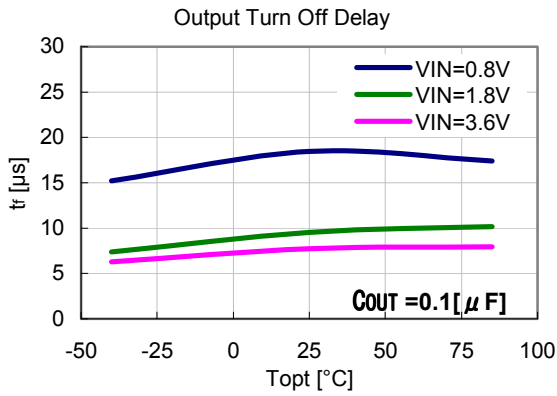

20) Output Fall time vs. Input voltage

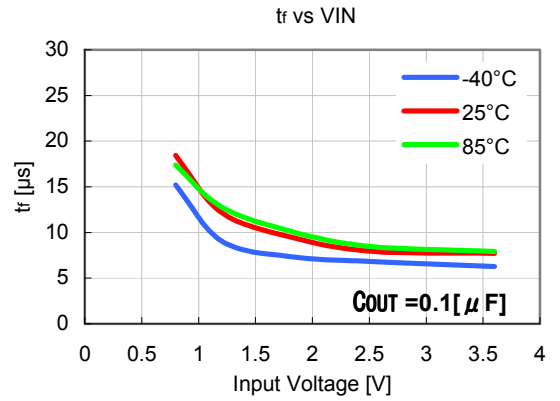

21) Reverse leakage current vs. Temperature

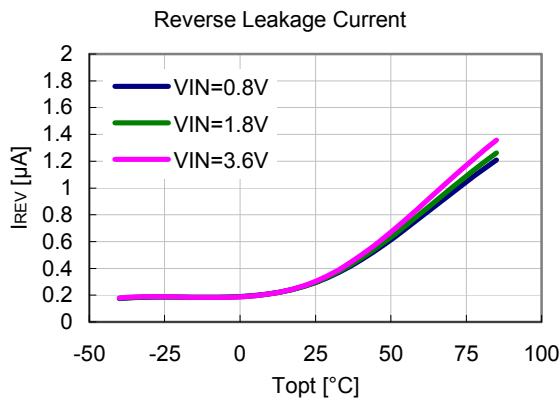

22) Reverse leakage current vs. Input voltage

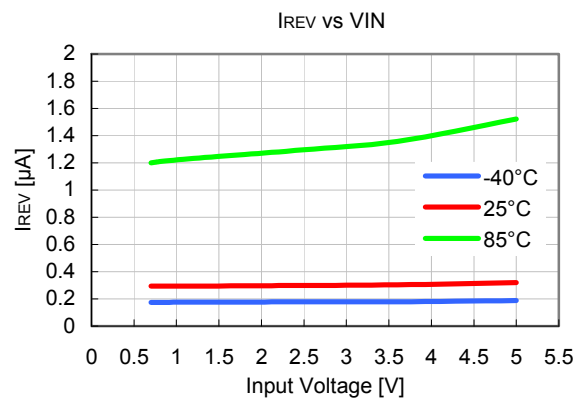

23) Discharge resistance vs. Temperature

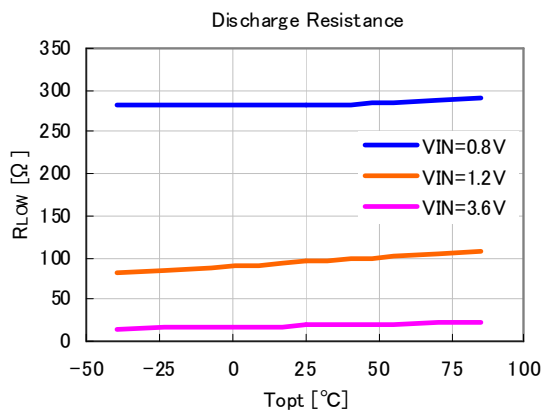

24) Discharge resistance vs. Input voltage

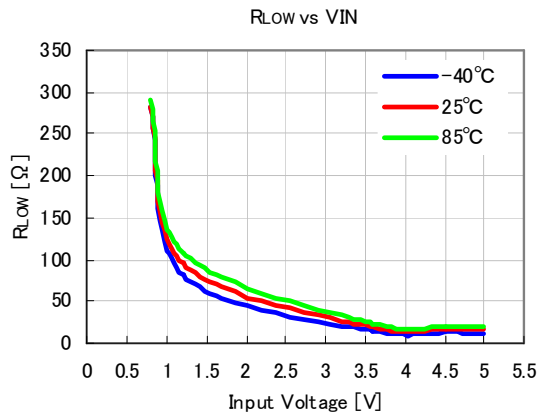

25) Current limit vs. Temperature (002x)

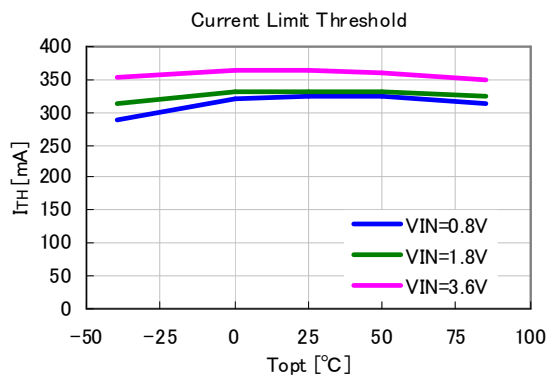

26) Current limit vs. Input voltage (002x)

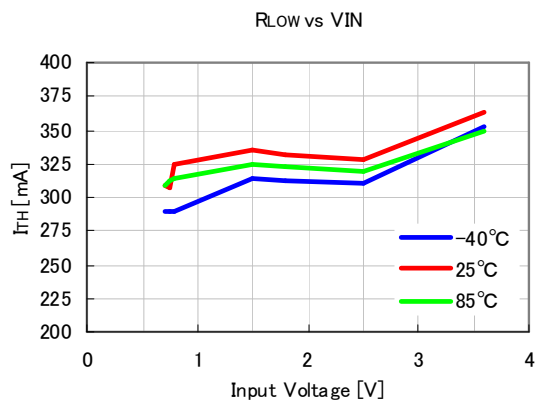

TIMING CHART

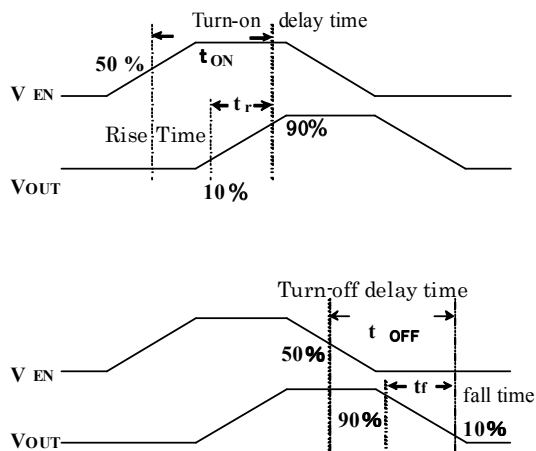

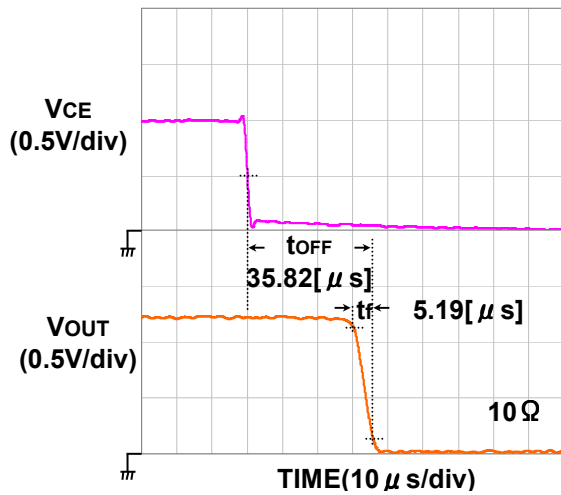
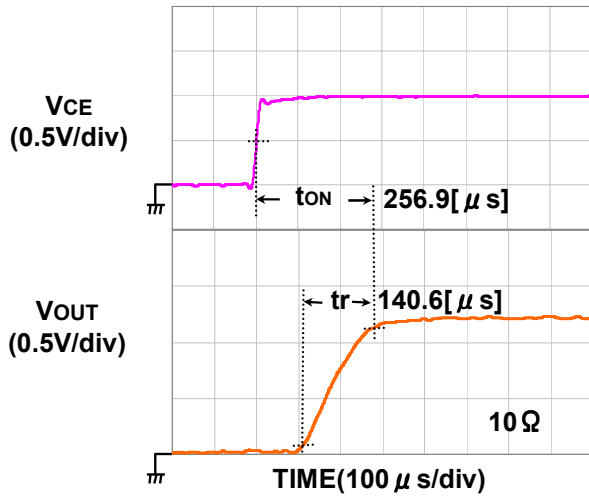
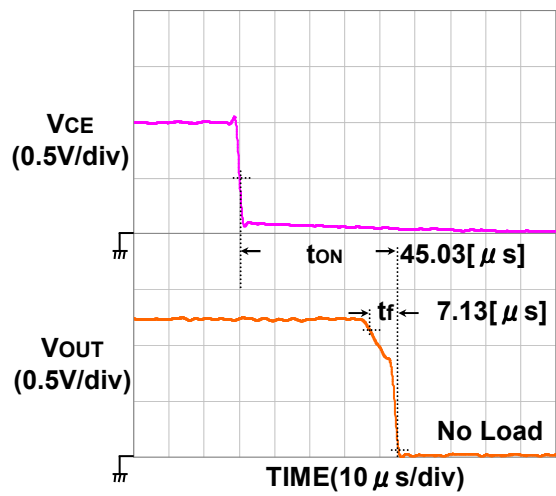
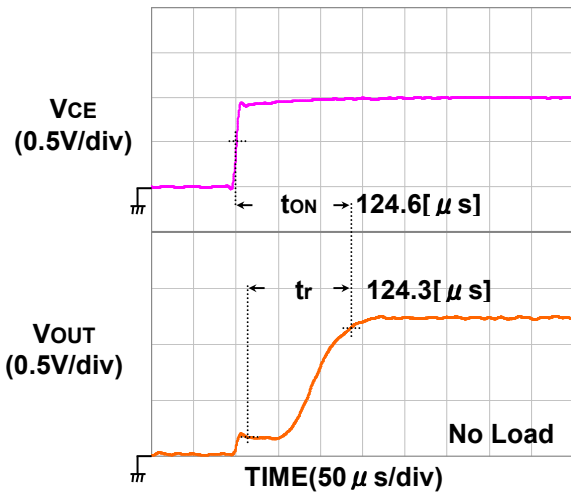
Turn-on/ turn-off waveform ( $V_{IN} = 1.2[V]$ )

## POWER DISSIPATION (DFN(PLP)1010-4F)

Power Dissipation ( $P_D$ ) depends on conditions of mounting on board. This specification is based on the measurement at the condition below:

### Measurement Conditions

	Standard Land Pattern
Environment	Mounting on Board (Wind velocity=0m/s)
Board Material	Glass cloth epoxy plastic (Double sided)
Board Dimensions	40mm×40mm×1.6mm
Copper Ratio	Top side: Approx. 50%, Back side: Approx. 50%
Through-holes	φ 0.54mm×24pcs

### Measurement Result

( $T_a=25^{\circ}\text{C}$ ,  $T_{j\text{max}}=125^{\circ}\text{C}$ )

	Standard Land Pattern
Power Dissipation	300mW
Thermal Resistance	$\theta_{ja}=(125-25^{\circ}\text{C})/0.3\text{W}=330^{\circ}\text{C/W}$
	$\theta_{jc}=48^{\circ}\text{C/W}$

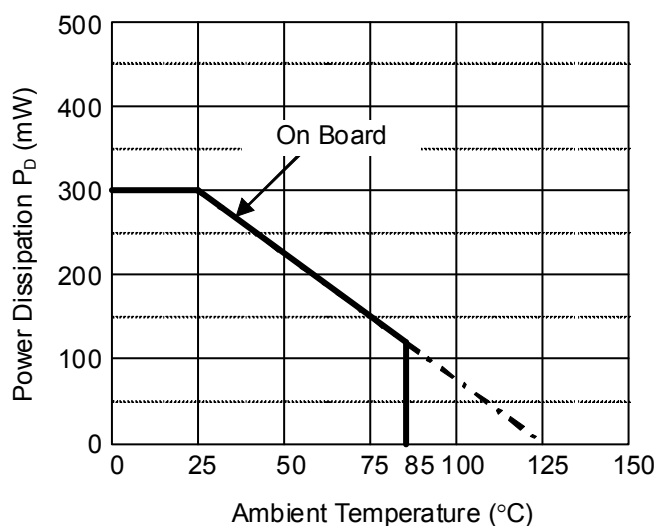

**Power Dissipation**

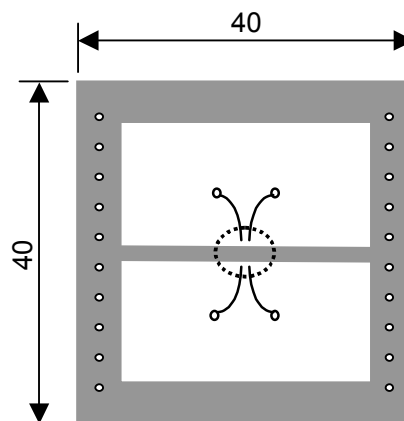

**Measurement Board Pattern**

○ IC Mount Area (Unit : mm)



1. The products and the product specifications described in this document are subject to change or discontinuation of production without notice for reasons such as improvement. Therefore, before deciding to use the products, please refer to Ricoh sales representatives for the latest information thereon.
2. The materials in this document may not be copied or otherwise reproduced in whole or in part without prior written consent of Ricoh.
3. Please be sure to take any necessary formalities under relevant laws or regulations before exporting or otherwise taking out of your country the products or the technical information described herein.
4. The technical information described in this document shows typical characteristics of and example application circuits for the products. The release of such information is not to be construed as a warranty of or a grant of license under Ricoh's or any third party's intellectual property rights or any other rights.
5. The products listed in this document are intended and designed for use as general electronic components in standard applications (office equipment, telecommunication equipment, measuring instruments, consumer electronic products, amusement equipment etc.). Those customers intending to use a product in an application requiring extreme quality and reliability, for example, in a highly specific application where the failure or misoperation of the product could result in human injury or death (aircraft, spacevehicle, nuclear reactor control system, traffic control system, automotive and transportation equipment, combustion equipment, safety devices, life support system etc.) should first contact us.
6. We are making our continuous effort to improve the quality and reliability of our products, but semiconductor products are likely to fail with certain probability. In order to prevent any injury to persons or damages to property resulting from such failure, customers should be careful enough to incorporate safety measures in their design, such as redundancy feature, fire containment feature and fail-safe feature. We do not assume any liability or responsibility for any loss or damage arising from misuse or inappropriate use of the products.
7. Anti-radiation design is not implemented in the products described in this document.
8. The X-ray exposure can influence functions and characteristics of the products. Confirm the product functions and characteristics in the evaluation stage.
9. WLCSP products should be used in light shielded environments. The light exposure can influence functions and characteristics of the products under operation or storage.
10. There can be variation in the marking when different AOI (Automated Optical Inspection) equipment is used. In the case of recognizing the marking characteristic with AOI, please contact Ricoh sales or our distributor before attempting to use AOI.
11. Please contact Ricoh sales representatives should you have any questions or comments concerning the products or the technical information.



**Ricoh is committed to reducing the environmental loading materials in electrical devices with a view to contributing to the protection of human health and the environment.**

Ricoh has been providing RoHS compliant products since April 1, 2006 and Halogen-free products since April 1, 2012.

**RICOH** RICOH ELECTRONIC DEVICES CO., LTD.

<https://www.e-devices.ricoh.co.jp/en/>

#### Sales & Support Offices

##### **Ricoh Electronic Devices Co., Ltd.**

###### **Shin-Yokohama Office (International Sales)**

2-3, Shin-Yokohama 3-chome, Kohoku-ku, Yokohama-shi, Kanagawa, 222-8530, Japan  
Phone: +81-50-3814-7687 Fax: +81-45-474-0074

##### **Ricoh Americas Holdings, Inc.**

675 Campbell Technology Parkway, Suite 200 Campbell, CA 95008, U.S.A.  
Phone: +1-408-610-3105

##### **Ricoh Europe (Netherlands) B.V.**

###### **Semiconductor Support Centre**

Prof. W.H. Keesomlaan 1, 1183 DJ Amstelveen, The Netherlands  
Phone: +31-20-5474-309

##### **Ricoh International B.V. - German Branch**

###### **Semiconductor Sales and Support Centre**

Oberrather Strasse 6, 40472 Düsseldorf, Germany  
Phone: +49-211-6546-0

##### **Ricoh Electronic Devices Korea Co., Ltd.**

3F, Haesung Bldg, 504, Teheran-ro, Gangnam-gu, Seoul, 135-725, Korea  
Phone: +82-2-2135-5700 Fax: +82-2-2051-5713

##### **Ricoh Electronic Devices Shanghai Co., Ltd.**

Room 403, No.2 Building, No.690 Bibo Road, Pu Dong New District, Shanghai 201203,  
People's Republic of China  
Phone: +86-21-5027-3200 Fax: +86-21-5027-3299

##### **Ricoh Electronic Devices Shanghai Co., Ltd.**

###### **Shenzhen Branch**

1205, Block D (Jinlong Building), Kingkey 100, Hongbao Road, Luohu District,  
Shenzhen, China  
Phone: +86-755-8348-7600 Ext 225

##### **Ricoh Electronic Devices Co., Ltd.**

###### **Taipei office**

Room 109, 10F-1, No.51, Hengyang Rd., Taipei City, Taiwan (R.O.C.)  
Phone: +886-2-2313-1621/1622 Fax: +886-2-2313-1623